





prama

Urban
Furniture &
Playgrounds

π

A Prama Play é uma empresa assente numa base experiente e sólida, fortemente suportada pelo know-how adquirido ao longo de mais 20 anos de presença no setor, e promete ser líder na comercialização de mobiliário urbano e equipamentos de lazer e desportivos de alta qualidade e design inovador.

A Prama Play oferece uma vasta gama de equipamentos de alta qualidade, dispondo de uma linha completa e variada de mobiliário urbano, parques infantis, recintos desportivos, iluminação pública e viária, pavimentos e muito mais. Dedicamo-nos à criação de espaços urbanos funcionais, esteticamente apelativos e sustentáveis, aliando a criatividade e a engenharia, para oferecer soluções que respondam às necessidades específicas dos nossos clientes e comunidades, e garantimos a durabilidade de cada peça através de inspeções periódicas, manutenção e reparações necessárias.

Abraçamos cada projeto com um objetivo principal: contribuir para o desenvolvimento de comunidades urbanas inovadoras e acolhedoras, onde as pessoas possam desfrutar de espaços públicos bem projetados, funcionalmente eficientes e em harmonia com o ambiente.

Para conhecer um pouco mais sobre o nosso projeto e os nossos produtos e serviços, estamos inteiramente à disposição. Para obter informações adicionais ou agendar uma reunião, não hesitem em contactar-nos. Teremos todo o gosto em explorar como podemos atender às vossas necessidades específicas.

Agradecemos antecipadamente a oportunidade de apresentar a nossa empresa e ambicionamos uma futura colaboração.

A equipa,

PRAMA PLAY

A-FLEX



PLÁSTICO POLIURETANO | POLYURETHANE PLASTIC



PFLEXHN

PFLEXHN

PFLEXHNP

+
BEXTRAP01

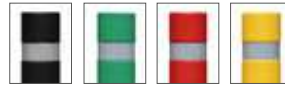

Colores estándar
Standard colors

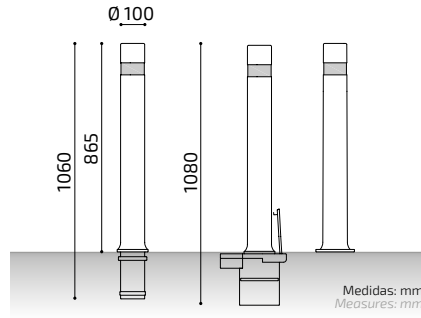

Flexibilidad 90°.
Flexibility 90°.



Opcional base con placa reforzada.
Optional base with reinforced plate.



Cinta reflectante amarilla.
Yellow reflective tape.



A-FLEX DT



PLÁSTICO POLIURETANO | POLYURETHANE PLASTIC



PFLEXDTHN

PFLEXDTHN

PFLEXDTHNP

+
BEXTRAP01



Colores estándar
Standard colors

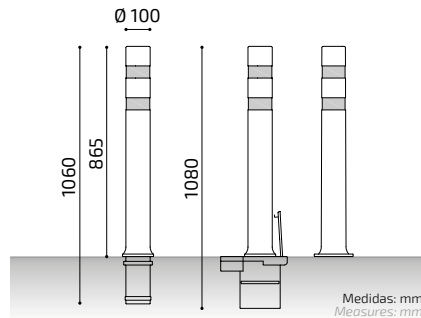

Flexibilidad 90°.
Flexibility 90°.



Opcional base con placa reforzada.
Optional base with reinforced plate.



Cinta reflectante amarilla.
Yellow reflective tape.



A-FLEX DT CARRIL BICI / A-FLEX DT FOR BICYCLE LANE



PLÁSTICO POLIURETANO | POLYURETHANE PLASTIC



Pilona homologada
Homologated bollard



PFLEXDTHG

PFLEXDTHG

PFLEXDTHGP

+
BEXTRAP01

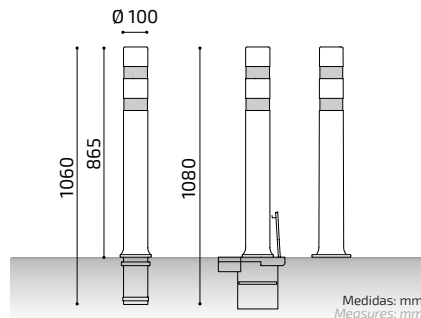

Flexibilidad 90°.
Flexibility 90°.



Opcional base con placa reforzada.
Optional base with reinforced plate.



Cinta reflectante amarilla.
Yellow reflective tape.



A-FLEX 80

PLÁSTICO POLIURETANO | POLYURETHANE PLASTIC



Colores estándar
Standard colors

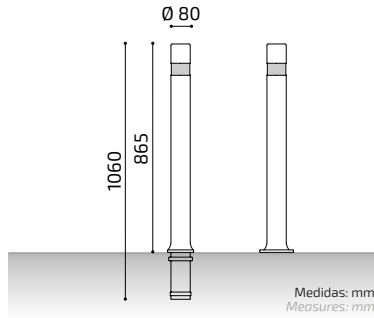

Medidas: mm.
Measures: mm.



Flexibilidad 90°.
Flexibility 90°.



Opcional base con placa reforzada.
Optional base with reinforced plate.



Cinta reflectante amarilla.
Yellow reflective tape.

A-FLEX DT 80

PLÁSTICO POLIURETANO | POLYURETHANE PLASTIC

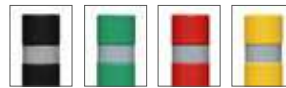

Colores estándar
Standard colors

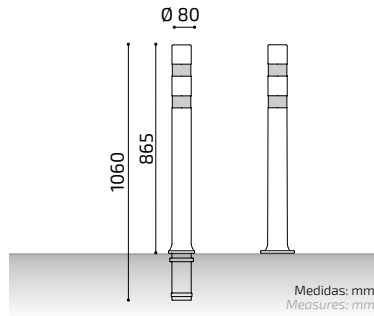

Medidas: mm.
Measures: mm.



Flexibilidad 90°.
Flexibility 90°.



Opcional base con placa reforzada.
Optional base with reinforced plate.



Cinta reflectante amarilla.
Yellow reflective tape.

A-FLEX BADALONA

PLÁSTICO POLIURETANO | POLYURETHANE PLASTIC

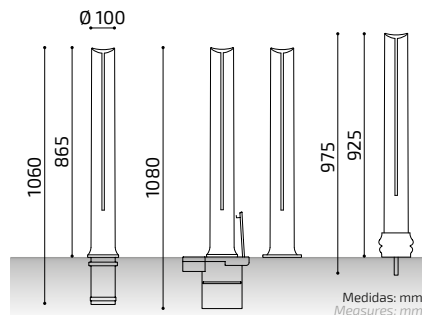

Medidas: mm.
Measures: mm.



Flexibilidad 90°.
Flexibility 90°.



Opcional base con placa reforzada.
Optional base with reinforced plate.

A-FLEX SANT FELIU

PLÁSTICO POLIURETANO | POLYURETHANE PLASTIC



PFSFHN

PFSFHN

PFSFHNP

PFSFHNT

+ **BEXTRAP01**

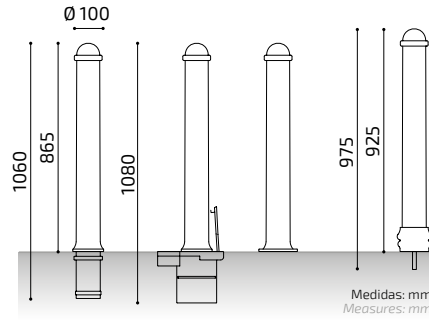

Flexibilidad 90°.
Flexibility 90°.



Opcional base con placa reforzada.
Optional base with reinforced plate.



A-FLEX AGBA

PLÁSTICO POLIURETANO | POLYURETHANE PLASTIC



PFAGBAHN

PFAGBAHN

PFAGBAHNP

PFAGBAHNT

+ **BEXTRAP01**

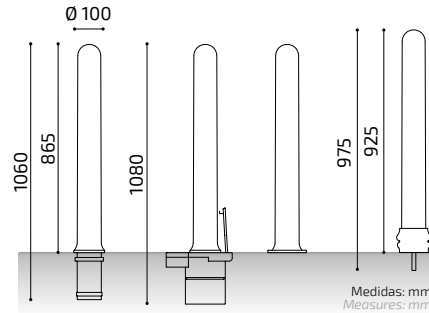

Flexibilidad 90°.
Flexibility 90°.



Opcional base con placa reforzada.
Optional base with reinforced plate.



A-FLEX FORUM

PLÁSTICO POLIURETANO | POLYURETHANE PLASTIC



PFFORUMHN

PFFORUMHN

PFFORUMHNP

PFFORUMHNT

+ **BEXTRAP01**

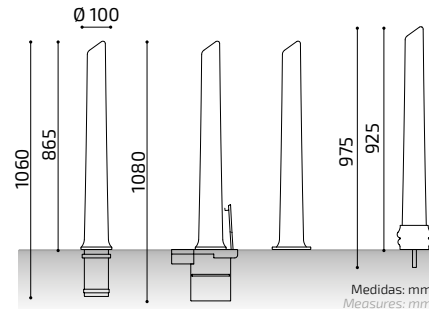

Flexibilidad 90°.
Flexibility 90°.



Opcional base con placa reforzada.
Optional base with reinforced plate.





A-BLEN



PLÁSTICO POLIURETANO | POLYURETHANE PLASTIC



Pilona flexible diseñada para la señalización vial, ideal para carreteras, carriles de bicicletas y parkings. Pilona muy resistente, después de un impacto recupera su forma original.

Flexible bollard designed for road signalization; can be used in roads; bike lanes and parkings. Excellent impact resistance; in case of impact it returns to its original shape and position.

A-BLEN



PLÁSTICO POLIURETANO | POLYURETHANE PLASTIC



Detalle superior.
Cap detail.



Colores estándar
Standard colors



Opcional: Llave fijación.
Optional: Key to fix the bollard.

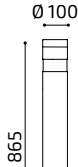

Medidas: mm.
Measures: mm.

PBLENN

LLFLEX



Flexibilidad 90°.
Flexibility 90°.



Cinta reflectante amarilla.
Yellow reflective tape.

A-BLEN DT



PLÁSTICO POLIURETANO | POLYURETHANE PLASTIC



Detalle superior.
Cap detail.



Colores estándar
Standard colors



Opcional: Llave fijación.
Optional: Key to fix the bollard.

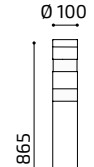

Medidas: mm.
Measures: mm.

PBLENDTN

LLFLEX



Flexibilidad 90°.
Flexibility 90°.



Cinta reflectante amarilla.
Yellow reflective tape.

A-BLEN DT CARRIL BICI A-BLEN DT FOR BICYCLE LANE



PLÁSTICO POLIURETANO | POLYURETHANE PLASTIC



Detalle superior.
Cap detail.



Opcional: Llave fijación.
Optional: Key to fix the bollard.

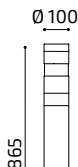

Medidas: mm.
Measures: mm.

PBLENDTG

LLFLEX



Flexibilidad 90°.
Flexibility 90°.



Cinta reflectante amarilla.
Yellow reflective tape.

A-BLEN TT



PLÁSTICO POLIURETANO | POLYURETHANE PLASTIC



Detalle superior.
Cap detail.



Colores estándar
Standard colors



Opcional: Llave fijación.
Optional: Key to fix the bollard.

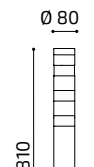

Medidas: mm.
Measures: mm.

PBLENTT80N

LLFLEX



Flexibilidad 90°.
Flexibility 90°.



Cinta reflectante amarilla.
Yellow reflective tape.



PILONAS LUMINOSAS CON LED FLEXIBLES Y SEMIFLEXIBLES

FLEXIBLE AND SEMI FLEXIBLE LED LIGHT BOLLARDS



Pilona flexible luminosa con led en la parte superior pudiendo elegir color de led blanco ó led rojo, Otros colores y configuraciones a consultar (leds RGB), programación horaria, ...

Flexible light bollard with led on the top led color can be chosen between white and red. Other colors, settings (leds RGB) and time scheduling to be consulted.

A-FLEX LEDS

PLÁSTICO POLIURETANO | POLYURETHANE PLASTIC



Leds / Leds

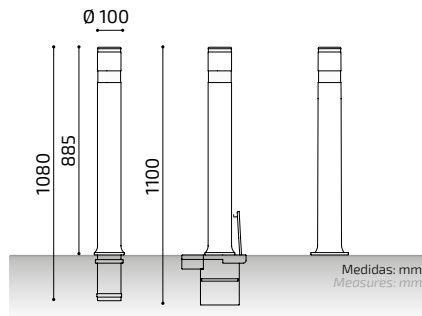

Flexibilidad 90°.
Flexibility 90°.



Posibilidad doble tira.
Double strip possibility.



Bajo consumo 12v.
Low-energy 12v.

A-ECO LEDS

PLÁSTICO POLIPROPILENO | POLYPROPYLENE PLASTIC



Leds / Leds

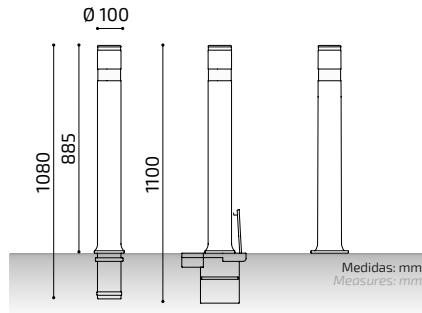

Flexibilidad limitada.
Limited flexibility.



Posibilidad doble tira.
Double strip possibility.



Bajo consumo 12v.
Low-energy 12v.

A-ECO

PLÁSTICO POLIPROPILENO | POLYPROPYLENE PLASTIC

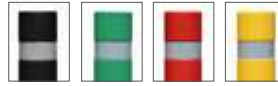

Colores estándar
Standard colors

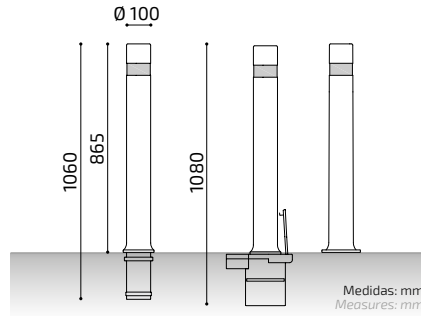

Medidas: mm.
Measures: mm.

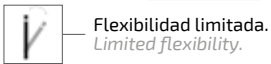

Flexibilidad limitada.
Limited flexibility.



Opcional base con placa reforzada.
Optional base with reinforced plate.



Cinta reflectante amarilla.
Yellow reflective tape.

A-ECO DT

PLÁSTICO POLIPROPILENO | POLYPROPYLENE PLASTIC



Colores estándar
Standard colors

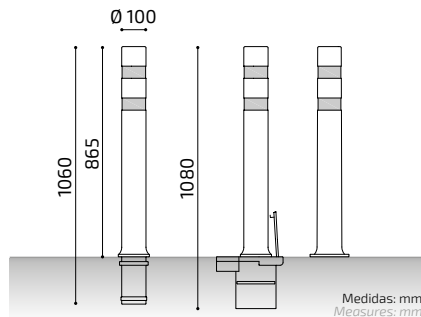

Medidas: mm.
Measures: mm.



Flexibilidad limitada.
Limited flexibility.



Opcional base con placa reforzada.
Optional base with reinforced plate.



Cinta reflectante amarilla.
Yellow reflective tape.

A-ECO BADALONA

PLÁSTICO POLIPROPILENO | POLYPROPYLENE PLASTIC

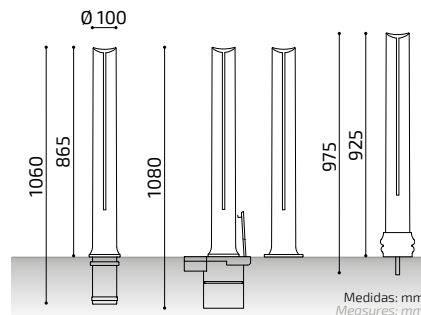

Medidas: mm.
Measures: mm.

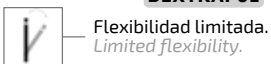

Flexibilidad limitada.
Limited flexibility.



Opcional base con placa reforzada.
Optional base with reinforced plate.

A-ECO SANT FELIU

PLÁSTICO POLIPROPILENO | POLYPROPYLENE PLASTIC

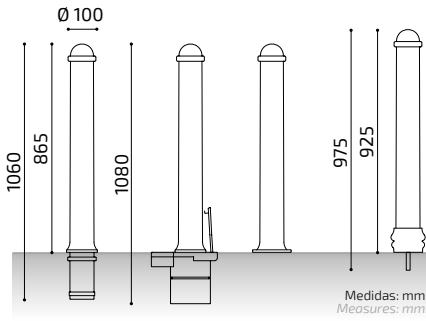

Medidas: mm.
Measures: mm.

PECSFHN **PECSFHN** + **BEXTRAP01** **PECSFHNP** **PECSFHNT**

 Flexibilidad limitada.
Limited flexibility.

 Opcional base con placa reforzada.
Optional base with reinforced plate.



A-ECO AGBA

PLÁSTICO POLIPROPILENO | POLYPROPYLENE PLASTIC

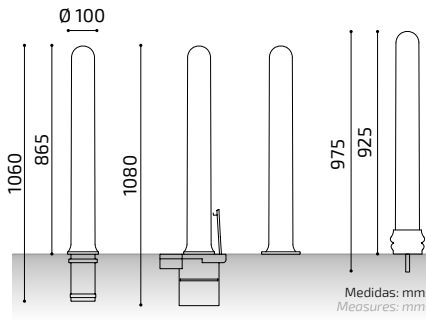

Medidas: mm.
Measures: mm.

PECAGBAHN **PECAGBAHN** + **BEXTRAP01** **PECAGBAHNP** **PECAGBAHNT**

 Flexibilidad limitada.
Limited flexibility.

 Opcional base con placa reforzada.
Optional base with reinforced plate.



A-ECO FORUM

PLÁSTICO POLIPROPILENO | POLYPROPYLENE PLASTIC

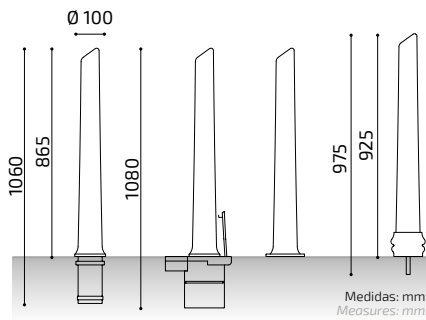

Medidas: mm.
Measures: mm.

PECFORUMHN **PECFORUMHN** + **BEXTRAP01** **PECFORUMHNP** **PECFORUMHNT**

 Flexibilidad limitada.
Limited flexibility.

 Opcional base con placa reforzada.
Optional base with reinforced plate.



HA75 - ECO

PLÁSTICO POLIETILENO | POLYETHYLENE PLASTIC

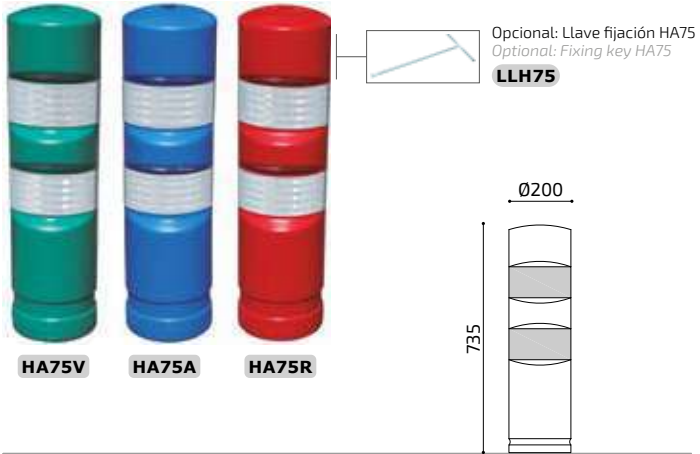

Medidas: mm.
Measures: mm.

HA75 - EVA

POLÍMERO TERMOPLÁSTICO + EVA | THERMOPLASTIC POLYMER + EVA

MAYOR RESISTENCIA A LOS IMPACTOS
HIGHER IMPACT RESISTANCE

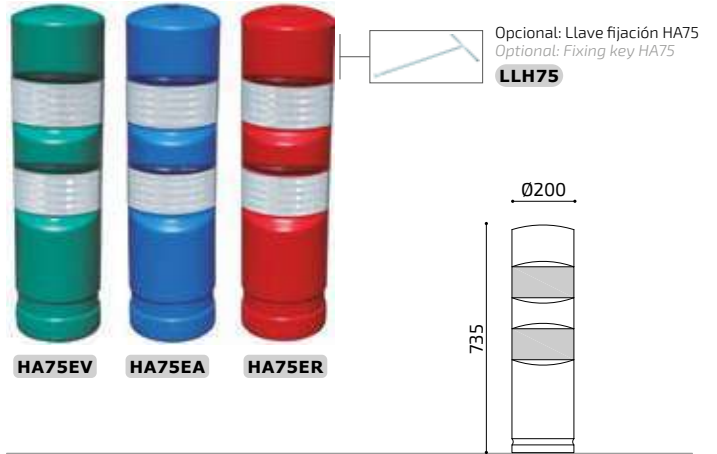

Medidas: mm.
Measures: mm.

ROAD

PLÁSTICO POLIURETANO | POLYURETHANE PLASTIC



SERIE AUSTRALASIA

AUTOMÁTICA - SEMIAUTOMÁTICA. USO INTENSIVO.

AUSTRALASIA SERIE

AUTOMATIC - SEMIAUTOMATIC. INTENSIVE USE.

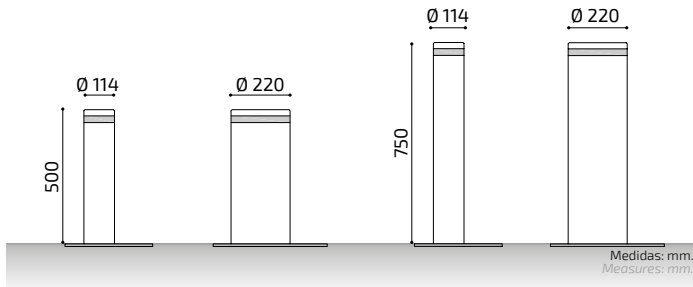

Instalación / Installation:



Bajo pedido AISI 316. / By request AISI 316.

SYDNEY

ACERO INOXIDABLE
STAINLESS STEEL



PEASY220X500

Espesor / Thickness

8,5 mm. Ø 114 mm.
8 mm. Ø 220 mm.

MELBOURNE

HIERRO GALVANIZADO
GALVANIZED IRON



PEAME220X500

Espesor / Thickness

10 mm. Ø 114 mm.
10 mm. Ø 220 mm.

SERIE ESCANDINAVIA

AUTOMÁTICA - SEMIAUTOMÁTICA. USO INTENSIVO.

ESCANDINAVIA SERIE

AUTOMATIC - SEMIAUTOMATIC. INTENSIVE USE.

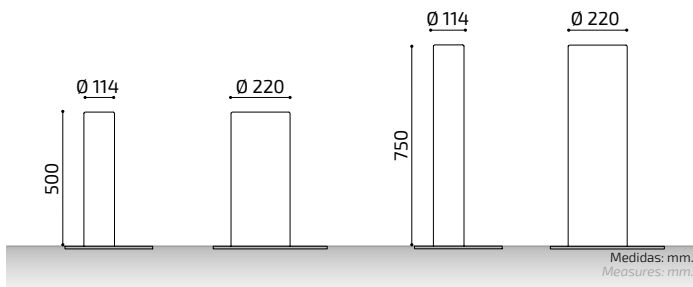

Instalación / Installation:



Bajo pedido AISI 316. / By request AISI 316.

OSLO

ACERO INOXIDABLE
STAINLESS STEEL



Opcional
Optional

PEMOS220X500

Espesor / Thickness

3 mm. Ø 114 mm.
3,7 mm. Ø 220 mm.

ESTOCOLMO

HIERRO GALVANIZADO
GALVANIZED IRON



Opcional
Optional

PEMES220X500

Espesor / Thickness

4 mm. Ø 114 mm.
5 mm. Ø 220 mm.

SERIE BENELUX

AUTOMÁTICA - SEMIAUTOMÁTICA. USO COMERCIAL

BENELUX SERIE

AUTOMATIC - SEMIAUTOMATIC. COMMERCIAL USE.

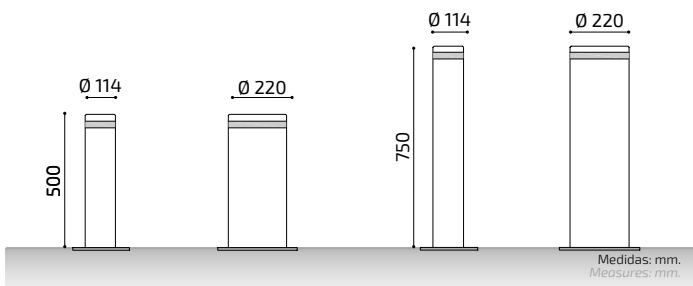

Instalación / Installation:



Bajo pedido AISI 316. / By request AISI 316.

LUXEMBURGO

ACERO INOXIDABLE
STAINLESS STEEL



PEMLU220X500

Espesor / Thickness

8,5 mm. Ø 114 mm.
8 mm. Ø 220 mm.

BRUSELAS

HIERRO GALVANIZADO
GALVANIZED IRON



PEMBR220X500

Espesor / Thickness

10 mm. Ø 114 mm.
10 mm. Ø 220 mm.

SERIE REINO UNIDO CE

AUTOMÁTICA - SEMIAUTOMÁTICA. USO COMERCIAL.

REINO UNIDO SERIE

AUTOMATIC - SEMIAUTOMATIC. COMMERCIAL USE.

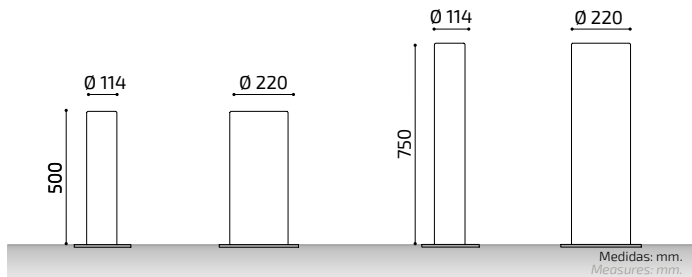

Instalación / Installation:



Bajo pedido AISI 316. / By request AISI 316.

CHELSEA

ACERO INOXIDABLE
STAINLESS STEEL



PEMCH114X500

Espesor / Thickness
3 mm. Ø 114 mm.
3,7 mm. Ø 220 mm.

LONDON

HIERRO GALVANIZADO
GALVANIZED IRON



PEML0220X500

Espesor / Thickness
4 mm. Ø 114 mm.
5 mm. Ø 220 mm.

SERIE UAE CE

AUTOMÁTICA - SEMIAUTOMÁTICA. USO INTENSIVO.

UAE SERIE

AUTOMATIC - SEMIAUTOMATIC. INTENSIVE USE.

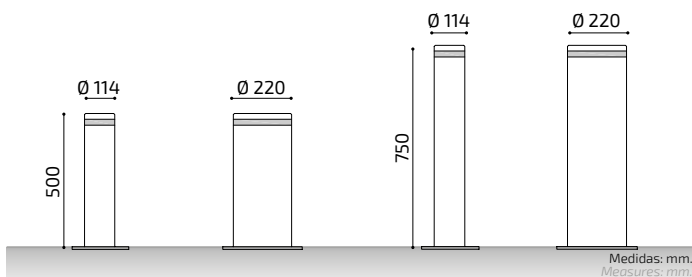

Instalación / Installation:



Bajo pedido AISI 316. / By request AISI 316.

ABU DABI

ACERO INOXIDABLE
STAINLESS STEEL



PEAAB220X500

Espesor / Thickness
8,5 mm. Ø 114 mm.
8 mm. Ø 220 mm.

DUBAI

HIERRO GALVANIZADO
GALVANIZED IRON



PEADU220X500

Espesor / Thickness
10 mm. Ø 114 mm.
10 mm. Ø 220 mm.

SERIE CANADÁ CE

AUTOMÁTICA - SEMIAUTOMÁTICA. USO INTENSIVO.

CANADA SERIE

AUTOMATIC - SEMIAUTOMATIC. INTENSIVE USE.

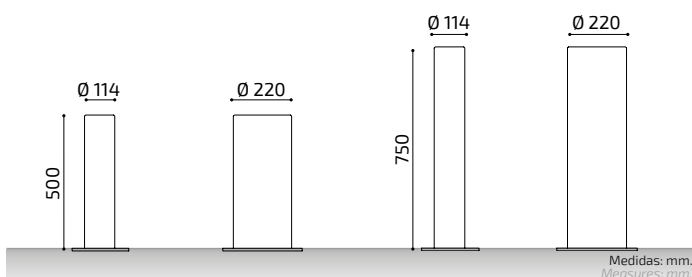

Instalación / Installation:



Bajo pedido AISI 316. / By request AISI 316.

TORONTO

ACERO INOXIDABLE
STAINLESS STEEL



PEATO220X500

Espesor / Thickness
3 mm. Ø 114 mm.
3,7 mm. Ø 220 mm.

MONTREAL

HIERRO GALVANIZADO
GALVANIZED IRON



PEAMO220X500

Espesor / Thickness
4 mm. Ø 114 mm.
5 mm. Ø 220 mm.

SERIE MEXICO

SEMIAUTOMÁTICA. USO MANUAL.



MEXICO SERIE

SEMIAUTOMATIC. MANUAL USE.

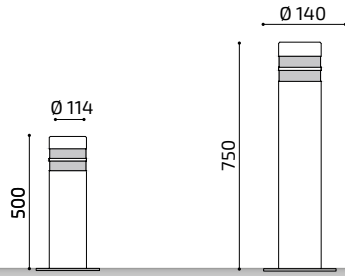

Medidas: mm.
Measures: mm.

Instalación / Installation:

 Chasis / Cajón perdido.
Chassis / Lost casing.

Bajo pedido AISI 316. / By request AISI 316.

CANCUN

ACERO INOXIDABLE
STAINLESS STEEL



PEMCA140X750

Espesor / Thickness
4mm. Ø 140 mm.

TIJUANA

HIERRO GALVANIZADO
GALVANIZED IRON



PEMTI140X750

Espesor / Thickness
4 mm. Ø 140 mm.

SERIE USA

AUTOMÁTICA · SEMIAUTOMÁTICA. USO INTENSIVO.



USA SERIE

AUTOMATIC · SEMIAUTOMATIC. INTENSIVE USE.

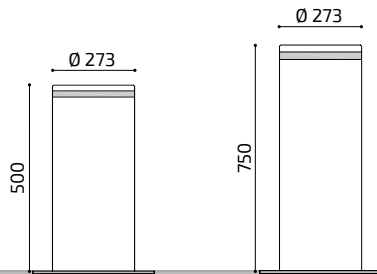

Medidas: mm.
Measures: mm.

Instalación / Installation:

 Chasis. +  Cajón perdido.
Chassis. + Lost casing.

Bajo pedido AISI 316. / By request AISI 316.

NEW YORK

ACERO INOXIDABLE
STAINLESS STEEL



Opcional
Optional

PEMNE273X500

Espesor / Thickness
4,2 mm. Ø 273 mm.
4,2 mm. Ø 273 mm.

WASHINGTON

HIERRO GALVANIZADO
GALVANIZED IRON



PEMWA273X500

Espesor / Thickness
6,3 mm. Ø 273 mm.
6,3 mm. Ø 273 mm.



CITY TELESCOPICA MANUAL CITY TELESCOPIC MANUAL

HIERRO GALVANIZADO + ACERO INOXIDABLE | GALVANIZED IRON + STAINLESS STEEL

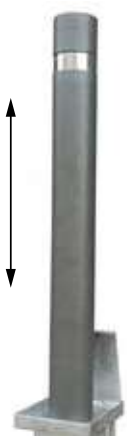

PEMCITY

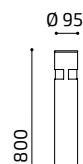

Medidas: mm.
Measures: mm.

Instalación: / Installation:

 Chasis. +  Cajón perdido.
Chassis. + Lost casing.

FUNCIONAMIENTO / BOLLARD OPERATION

- 1- Levantar tapa para acceder a la cerradura de la pizona.
Lift the cover to access the bollard.
- 2- Desbloquear llave y girar la pizona con ayuda de la anilla superior.
Unlock the key and rotate the bollard with help of the upper knocker.
- 3- Tirar de la anilla superior para subir la pizona y girarla para fijarla.
Pull the knocker to raise the bollard and rotate it again to fix it.
- 4- Bloquear la pizona en esa posición girando la llave y apretar el botón de la cerradura para que este no sobresalga.
Lock the bollard in that position by turning the key, be sure to press the lock button.

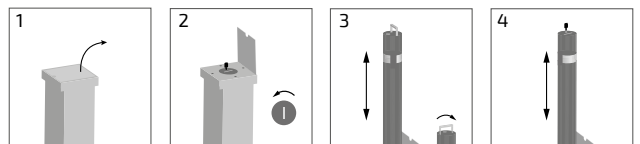

+ | **ACCESORIOS PILONAS ESCAMOTEABLES**
TELESCOPIC BOLLARDS ACCESSORIES

+ | **SISTEMAS DE APERTURA / APERTURE SYSTEMS**



Mandos a distancia.
Remote control.



Tarjetas apertura.
Keycard.



Sistema TAG.
TAG system.



Llavín.
Latchkey.



Botonera.
Push button station.

+ | **SISTEMAS DE APERTURA A DISTANCIA / REMOTE OPENING SYSTEMS**



Interfono GSM.
GSM intercom.



Sistema GSM.
GSM system.

+ | **SISTEMAS DE APERTURA LECTOR MATRÍCULAS**
PLATE RECOGNITION OPENING SYSTEMS



Lector de matrículas.
Car-plate recognition.



+ | **SISTEMAS DE APERTURA PARA VEHÍCULOS DE EMERGENCIA**
EMERGENCY VEHICLE OPENING SYSTEMS

Detector sonido (identifica la señal de las sirenas homologadas, ambulancias, policías, bomberos,...) y baja las pilonas para permitir el paso de los vehículos de emergencias sin detenerse.

Sound detector (identifies the signal of certified sirens, ambulances, police, firefighters, etc.) and lowers the bollards to allow the passage of emergency vehicles without stopping.





ACABADOS OPCIONALES PILONAS OPTIONAL FINISHES FOR BOLLARDS.



Corona luminosa CILPE.
CILPE Led ring.



Fresado extra.
Extra milling.



Personalización logo.
Customized logo.



Pilona gradiente.
Gradient bollard.



Micros posición.
Limit switches.



ACCESORIOS INSTALACIONES / ACCESSORIES FOR INSTALLATIONS



Tapa provisional obra.
Steel Road plate.



Detección apertura-tapa.
Top opening detector.



Lazo magnético.
Metallic mass detector.



Kit de conexión.
Connexion kit.



Interruptor horario anual.
Annual time switch.



Señal tráfico.
Traffic signals.



Semáforos.
Traffic lights.



Kit calefacción.
Heating.



Alarma manipulado pilona.
Tampered bollard alarm.



Cajón perdido.
Lost casing.

Poste Control Accesos | Control Post URBAN

ACERO INOXIDABLE | STAINLESS STEEL



PCACCES02



Opcional protector semáforo
Optional traffic light protector

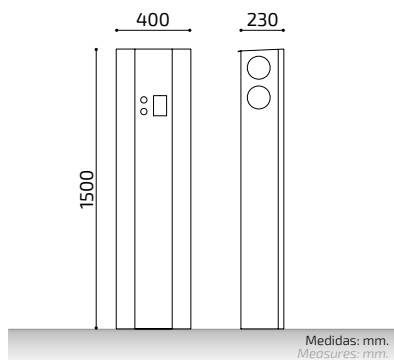

Poste Control Accesos | Control Post METROPOLIS

ACERO INOXIDABLE | STAINLESS STEEL



PCACCES04

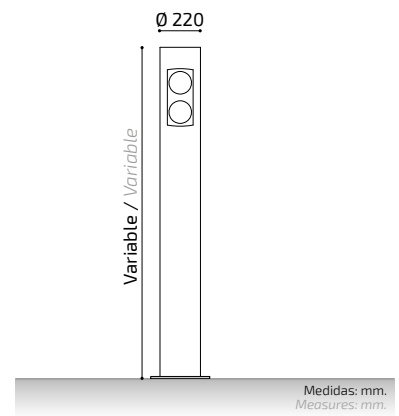

CITY

HIERRO GALVANIZADO + INOX. | GALVANIZED IRON + STAINLESS STEEL



Cantos redondeados.
Rounded edges.

Reforzada.
Reinforced.

Logo opcional.
Optional logo.



Placa opcional.
Optional plate.

Opción con candado.
Padlocked option.

BARCECO

HIERRO + INOX. | IRON + STAINLESS STEEL

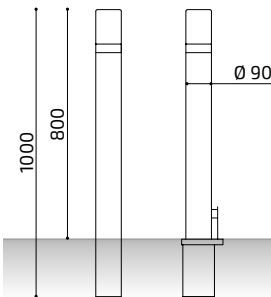
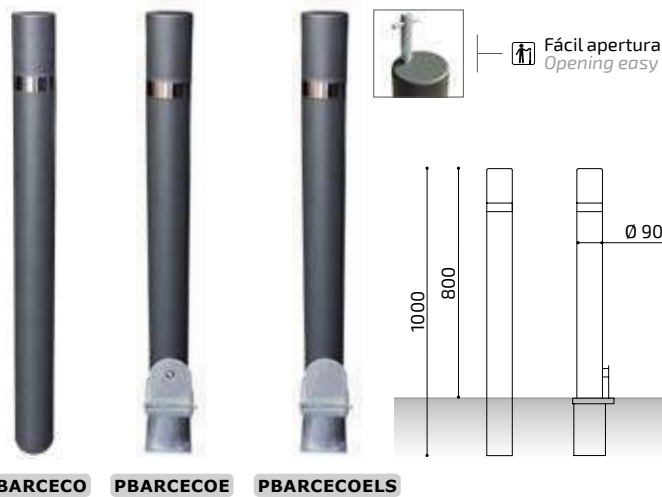

Placa opcional.
Optional plate.

Opción con candado.
Padlocked option.

URBAN

HIERRO GALVANIZADO + INOX. | GALVANIZED IRON + STAINLESS STEEL

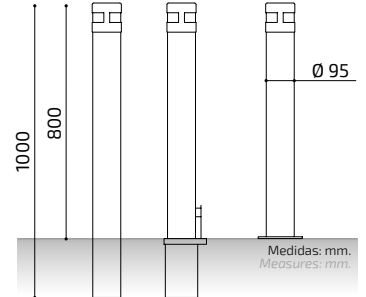
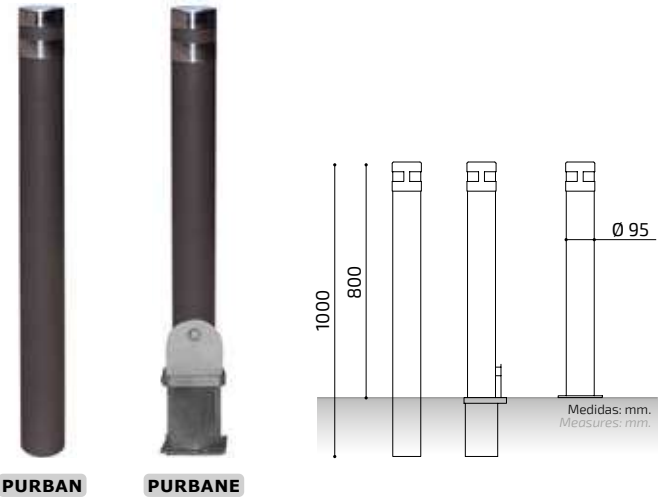

Placa opcional.
Optional plate.

Opción con candado.
Padlocked option.

CUBE

HIERRO GALVANIZADO + INOX. | GALVANIZED IRON + STAINLESS STEEL

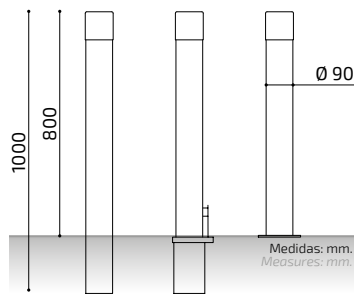
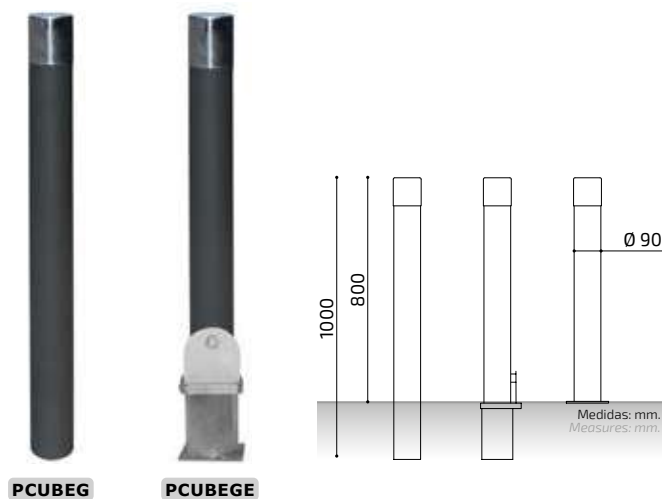

Placa opcional.
Optional plate.

Opción con candado.
Padlocked option.

TAP

HIERRO GALVANIZADO + INOX. | GALVANIZED IRON + STAINLESS STEEL

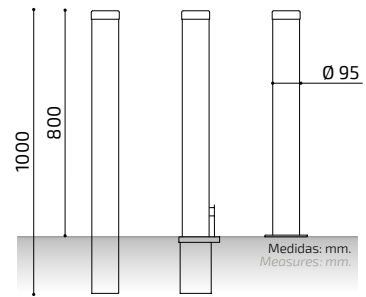
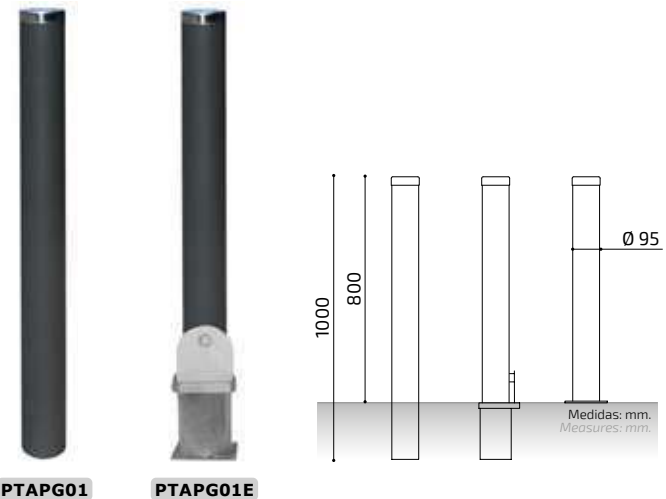

Placa opcional.
Optional plate.

Opción con candado.
Padlocked option.

TUBULAR

HIERRO GALVANIZADO • HIERRO | GALVANIZED IRON • IRON

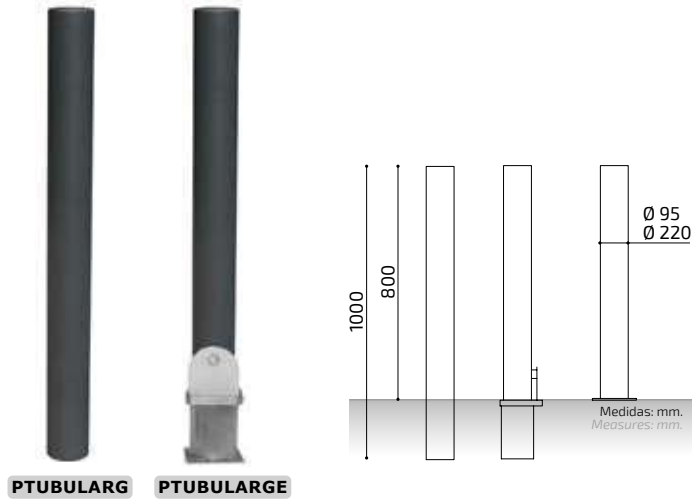

PTUBULARG **PTUBULARGE**



Placa opcional.
Optional plate.



Opción con candado.
Padlocked option.

CILINDRO

HIERRO GALVANIZADO • HIERRO | GALVANIZED IRON • IRON

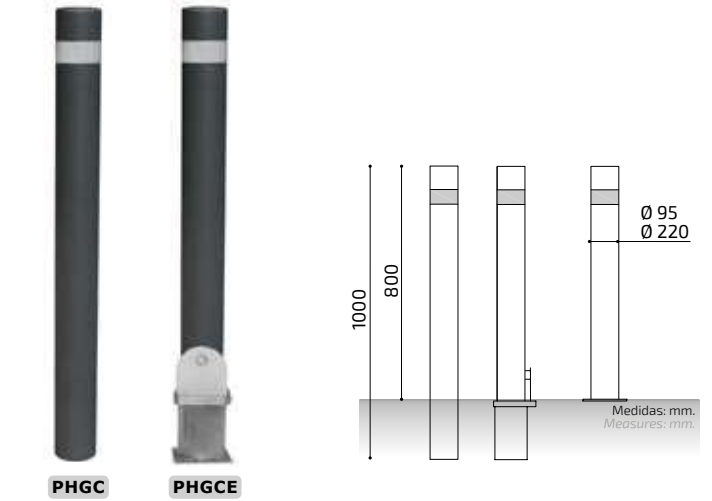

PHGC **PHGCE**



Placa opcional.
Optional plate.



Opción con candado.
Padlocked option.

GRANOLLERS

HIERRO | IRON

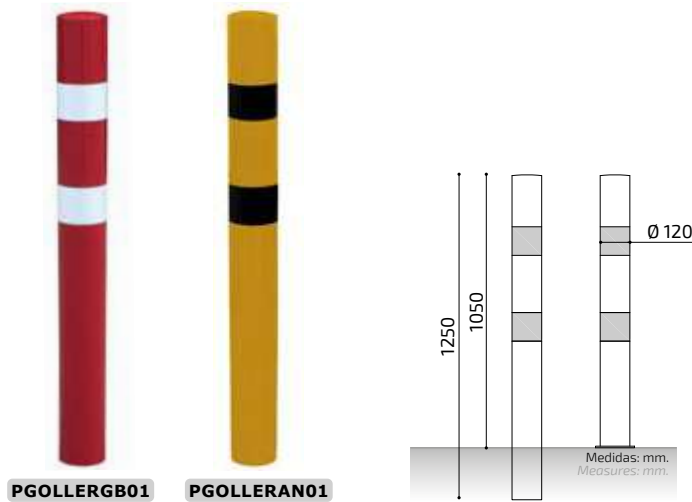

PGOLLERB01 **PGOLLERAN01**

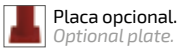

Placa opcional.
Optional plate.



Opción con candado.
Padlocked option.

CORTE

HIERRO GALVANIZADO • HIERRO | GALVANIZED IRON • IRON

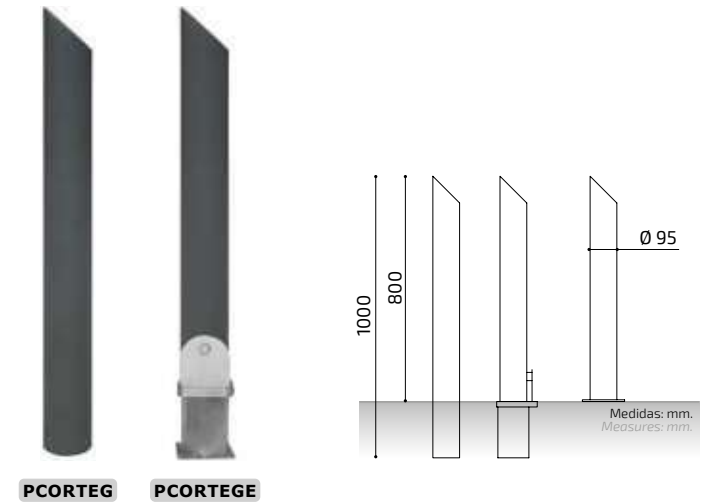

PCORTEG **PCORTEGE**



Placa opcional.
Optional plate.



Opción con candado.
Padlocked option.

GREY

HIERRO | IRON

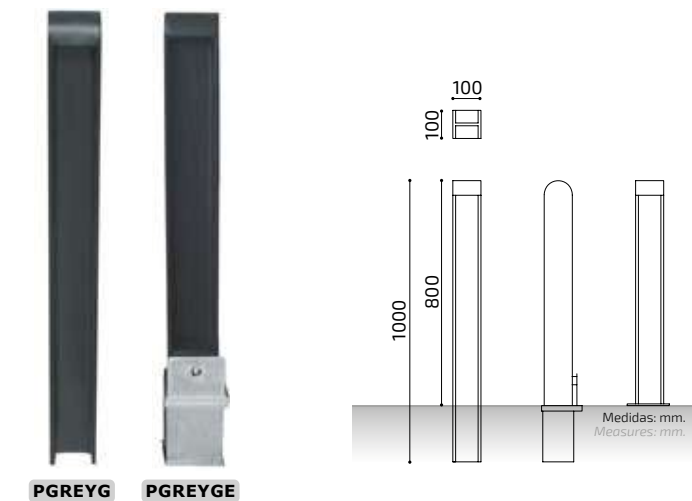

PGREYG **PGREYGE**



Placa opcional.
Optional plate.



Opción con candado.
Padlocked option.

IPN

HIERRO | IRON

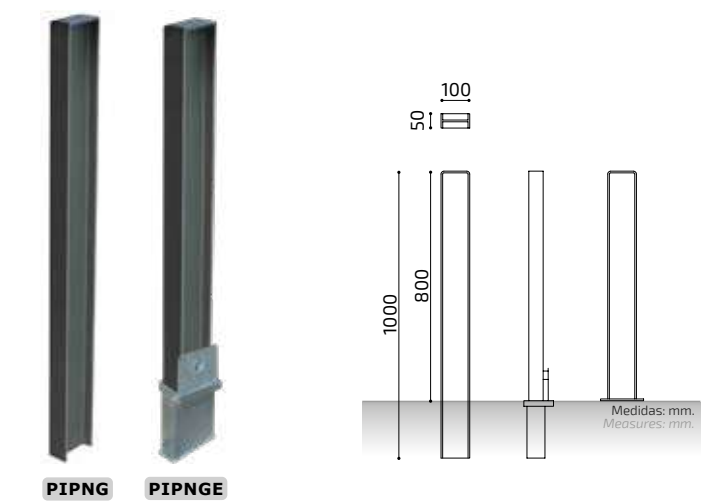

PIPNG **PIPNGE**



Placa opcional.
Optional plate.



Opción con candado.
Padlocked option.

FLAG

HIERRO | IRON



Bajo pedido, personalización de colores / banderas.

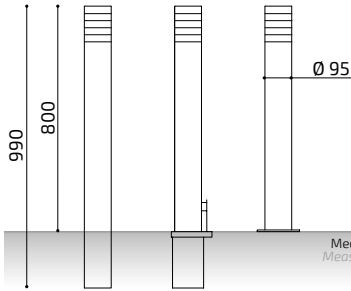

Medidas: mm.
Measures: mm.

PFLAG01

PFLAG01E



Placa opcional.
Optional plate.



Opción con candado.
Padlocked option.

BADALONA

HIERRO | IRON

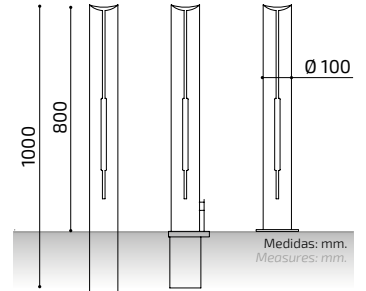

Medidas: mm.
Measures: mm.

PHBDN

PHBDNE



Placa opcional.
Optional plate.



Opción con candado.
Padlocked option.

ESQUIROL

HIERRO | IRON



Opcional
Optional

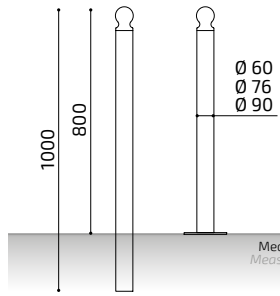

Medidas: mm.
Measures: mm.

PESQUIROL01



Placa opcional.
Optional plate.

PROTECTOR

HIERRO GALVANIZADO • CORTEN | GALVANIZED IRON • CORTEN

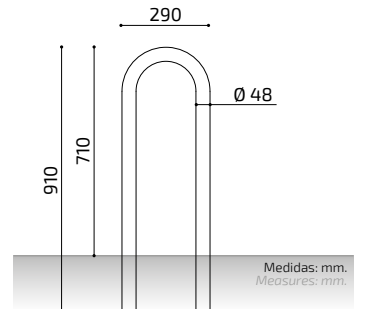
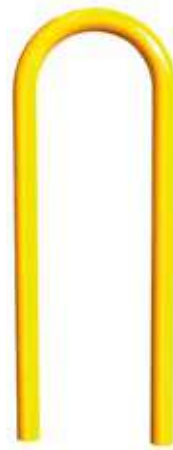

Medidas: mm.
Measures: mm.

PPROTECTORAM

PROTEC

HIERRO | IRON



Detalle
Detail

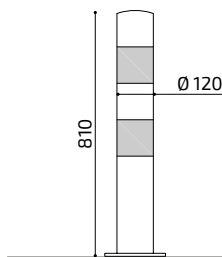

Medidas: mm.
Measures: mm.

PPROTECRB

PPROTECAMN

HELMET

HIERRO | IRON



Detalle
Detail

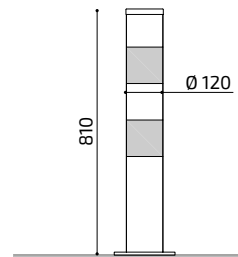

Medidas: mm.
Measures: mm.

PHELMETRB

PHELMETAMN

WEMBLEY

HIERRO GALVANIZADO | GALVANIZED IRON



Opcional
Optional

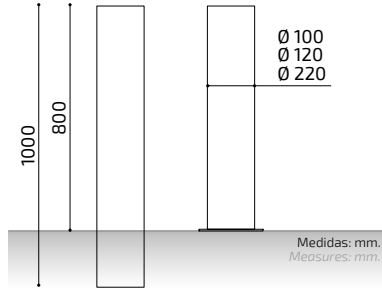

PWEMBLEY

 Placa opcional.
Optional plate.

MK

HIERRO | IRON



Opcional
Optional

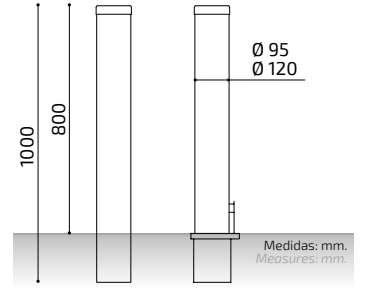

PMKAM

PMKAME

OLD

CORTEN | CORTEN STEEL

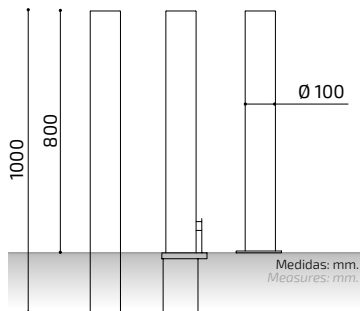

POLDC100

POLDC100E

 Placa opcional.
Optional plate. |  Opción con candado.
Padlocked option.

DESMON

HIERRO | IRON

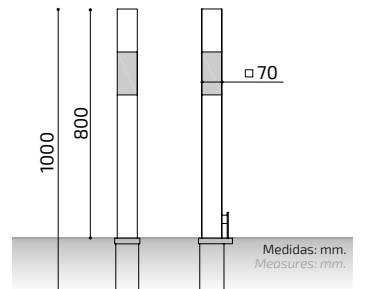

PDESMON

+ PILONAS DE HORMIGÓN / CONCRETE BOLLARDS



Hormigón



Semiesfera hormigón



Cube



Deca



Cilin



Leo



ROPE

MADERA | WOOD



PROPE100

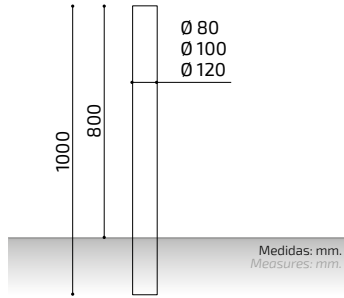

PINO

MADERA | WOOD



PPINO



PPINOE



Opción Eco (136 mm)
Eco option (136 mm)

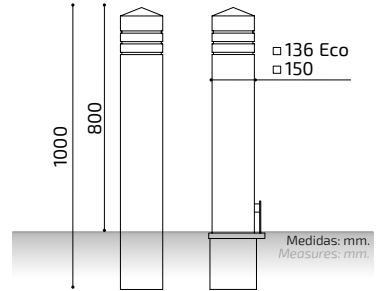

INOX

ACERO INOX. | STAINLESS STEEL



PINOX104B



PINOX104BE

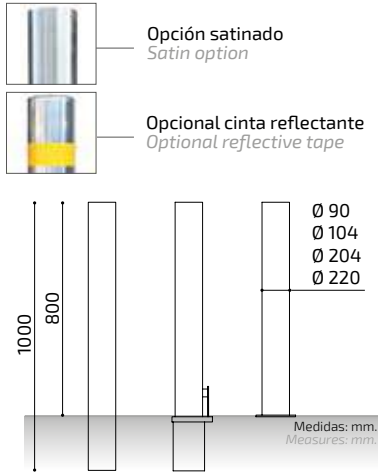

 Placa opcional.
Optional plate.

 Opción con candado.
Padlocked option.

DECOR

ACERO INOX. | STAINLESS STEEL



PIDECOR104B



PIDECOR104BE

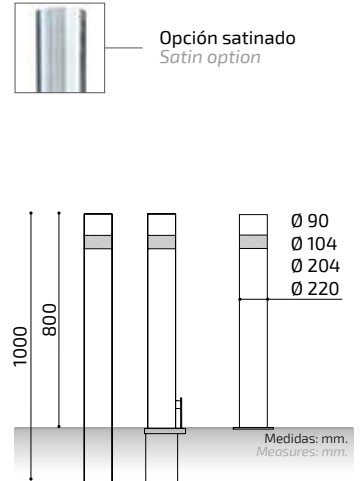

 Placa opcional.
Optional plate.

 Opción con candado.
Padlocked option.

TECOR

ACERO INOX. | STAINLESS STEEL



PITECOR104B



PITECOR104BE

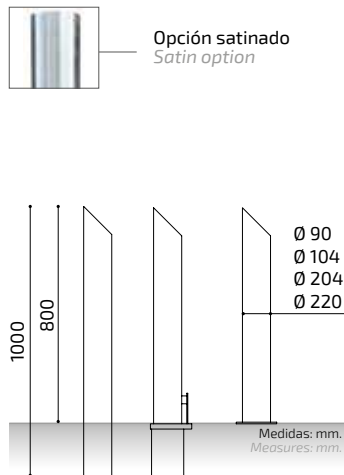

 Placa opcional.
Optional plate.

 Opción con candado.
Padlocked option.

TECORA

ACERO INOX. | STAINLESS STEEL



PITECORA104B



PITECORA104BE

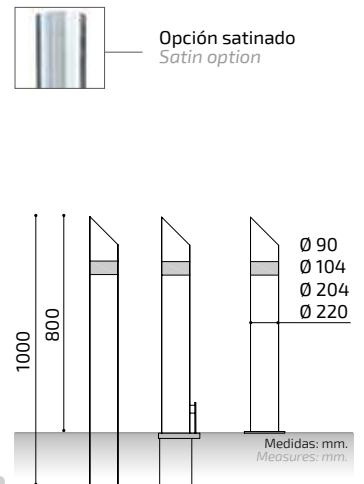

 Placa opcional.
Optional plate.

 Opción con candado.
Padlocked option.

BCN

HIERRO | IRON

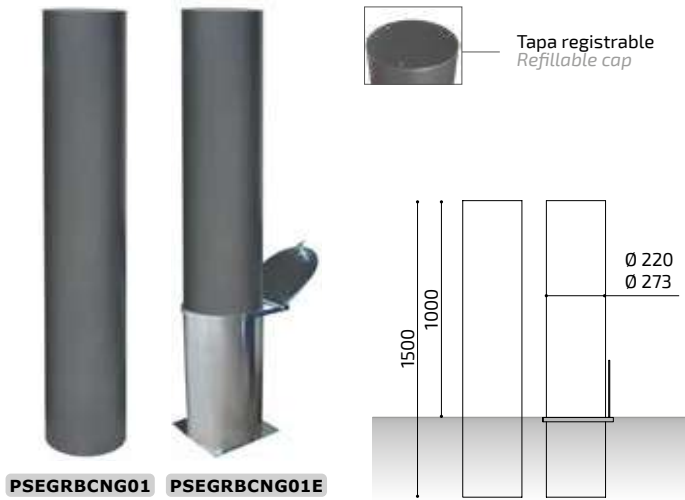

Rellenable hormigón.
Refillable concrete.

BARCELONA

HIERRO + ACERO INOX. | IRON + STAINLESS STEEL

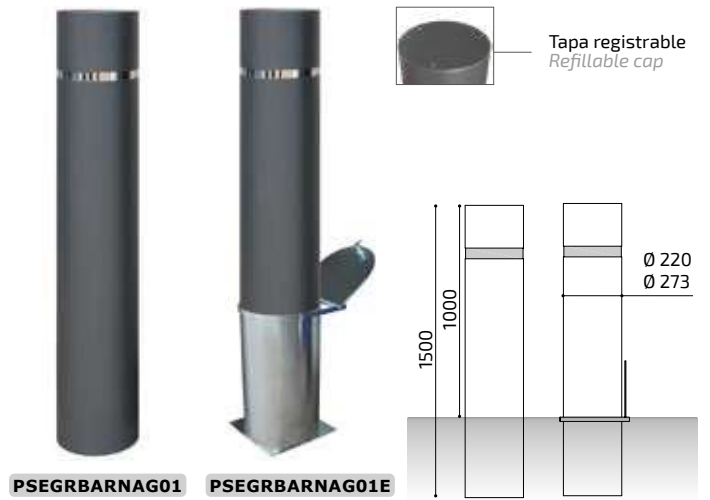

Rellenable hormigón.
Refillable concrete.

BIG GREY

HIERRO | IRON

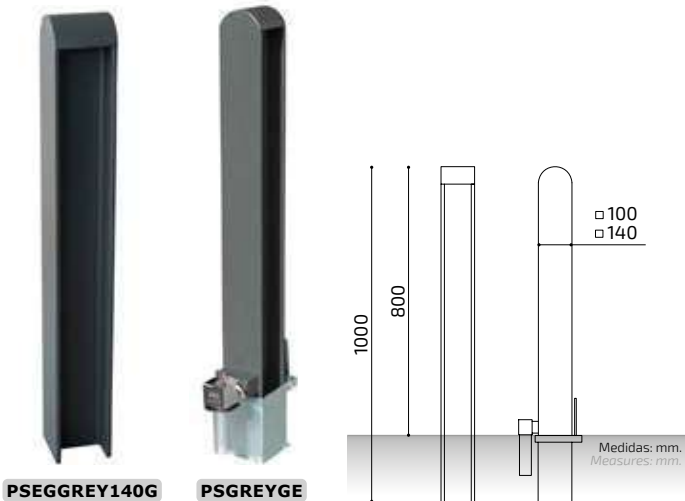

Base galvanizada.
Galvanized Base.

MK EXTRAÍBLE

HIERRO | IRON

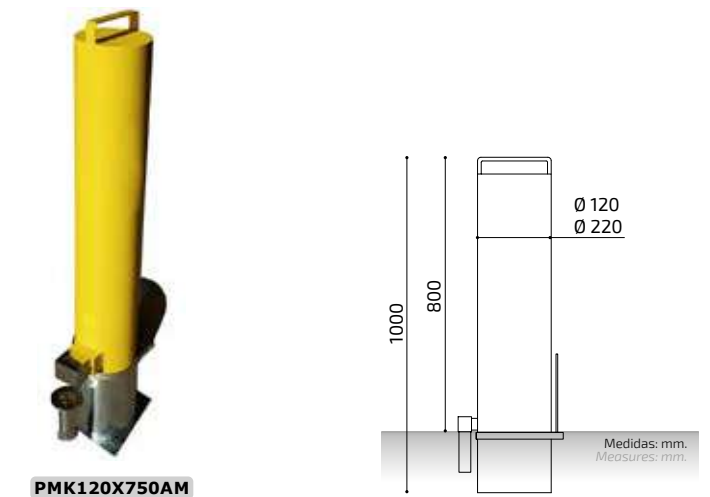

Base galvanizada.
Galvanized Base.

CIRCULAR

HIERRO • ACERO INOX. | IRON • STAINLESS STEEL



Rellenable hormigón.
Refillable concrete.

CIRCULAR ECO

HIERRO • ACERO INOX. | IRON • STAINLESS STEEL

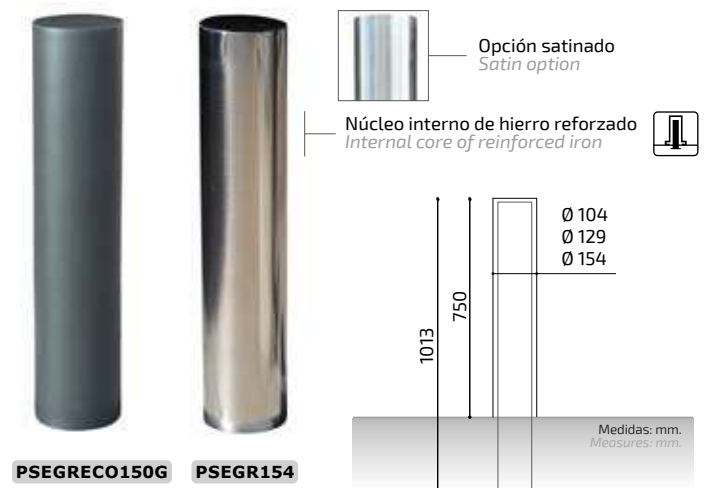

Rellenable hormigón.
Refillable concrete.

CUADRADA INOX

ACERO INOX. | STAINLESS STEEL

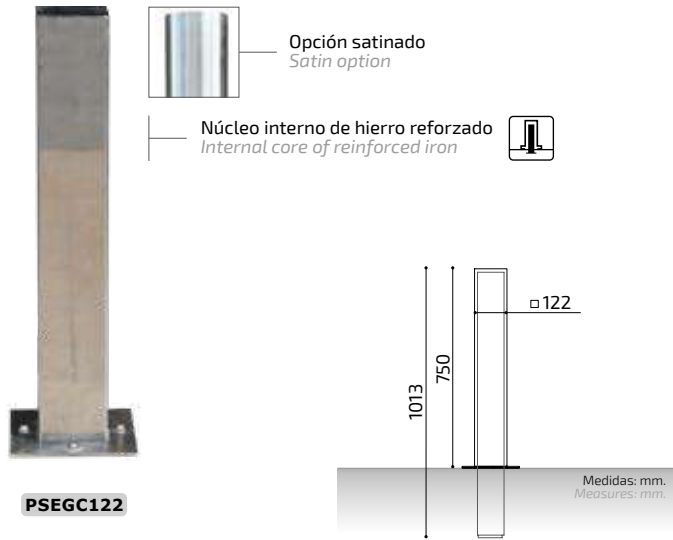

PSEGC122

Rellenable hormigón.
Refillable concrete.

INOX EXTRAÍBLE

ACERO INOX. | STAINLESS STEEL



PSGR104E

Rellenable hormigón.
Refillable concrete.



PILONAS LUMINOSAS | LIGHT BOLLARDS

CITY LED

HIERRO GALVANIZADO + INOX. | GALVANIZED IRON + STAINLESS STEEL

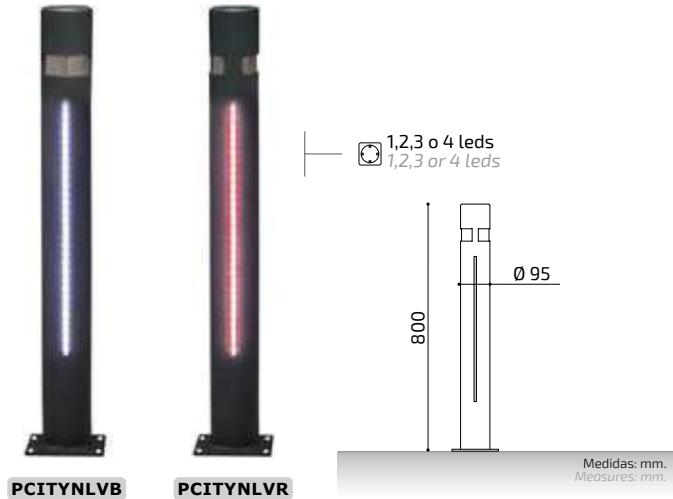

PCITYNLVB

PCITYNLVR

Bajo consumo 12v.
Low-energy 12v.

CITY LED HEAD

HIERRO | IRON

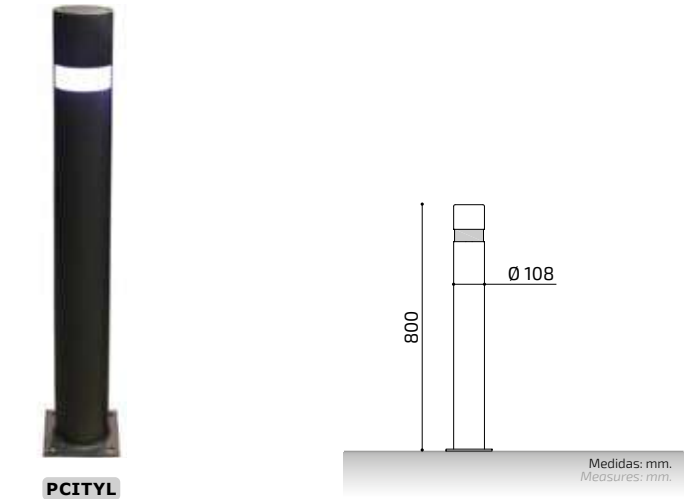

PCITYL

Bajo consumo 12v.
Low-energy 12v.

URBAN LED

HIERRO GALVANIZADO + INOX. | GALVANIZED IRON + STAINLESS STEEL

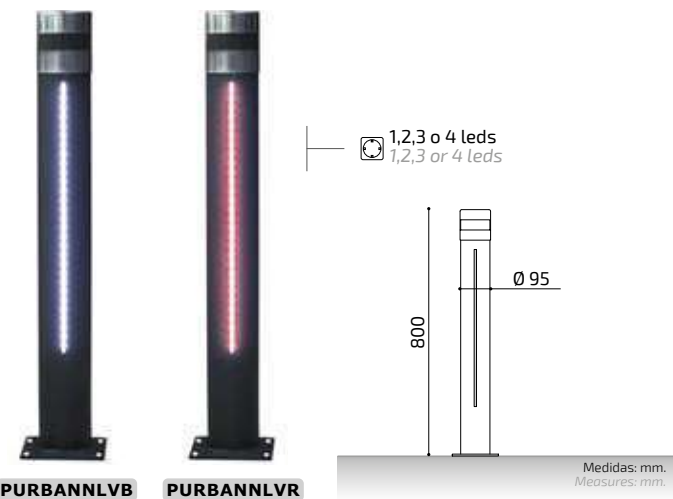

PURBANNLVB

PURBANNLVR

Bajo consumo 12v.
Low-energy 12v.

URBAN LED HEAD

HIERRO GALVANIZADO + INOX. | GALVANIZED IRON + STAINLESS STEEL

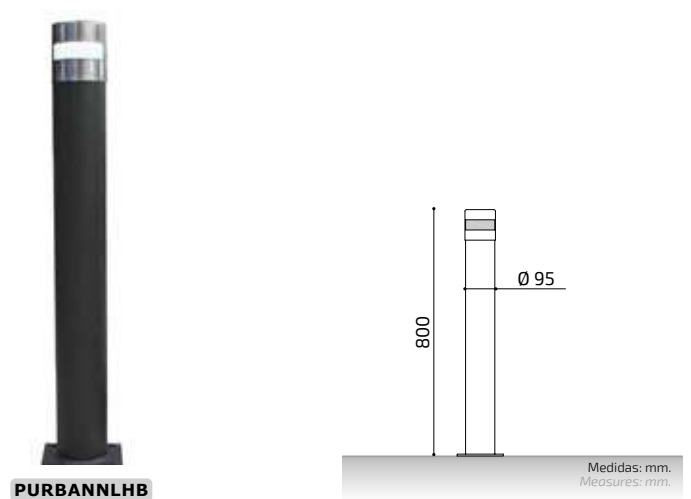

PURBANNLHB

Bajo consumo 12v.
Low-energy 12v.

TAP LED

HIERRO GALVANIZADO + INOX. | GALVANIZED IRON + STAINLESS STEEL

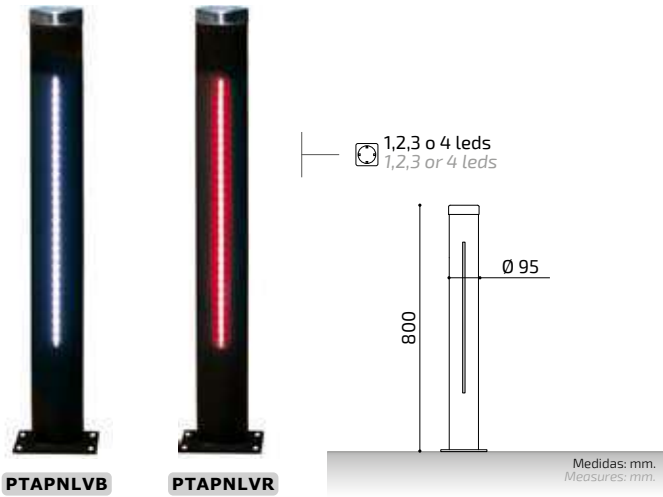

Bajo consumo 12v.
Low-energy 12v.

TAP LED TOP

HIERRO GALVANIZADO + HIERRO | GALVANIZED IRON + IRON

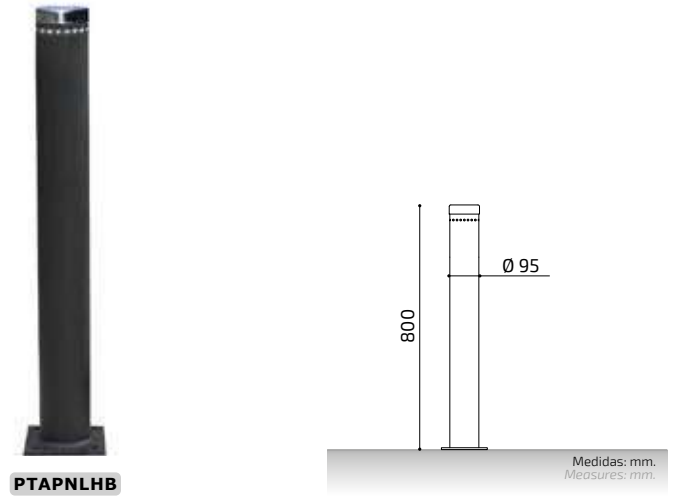

Bajo consumo 12v.
Low-energy 12v.

KRONO

ACERO INOX. | STAINLESS STEEL

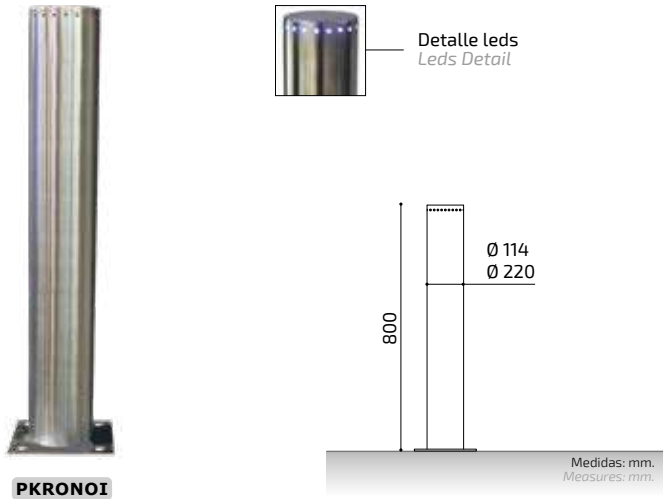

Bajo consumo 12v.
Low-energy 12v.

ROGI

ACERO INOX. | STAINLESS STEEL

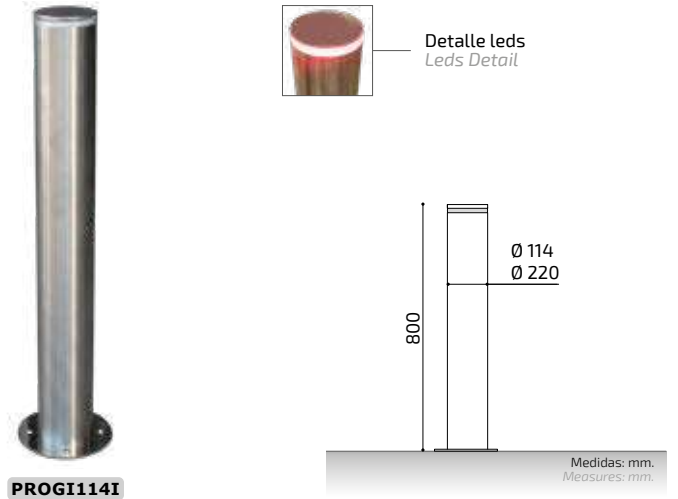

Bajo consumo 12v.
Low-energy 12v.

INOX LED

ACERO INOX. | STAINLESS STEEL

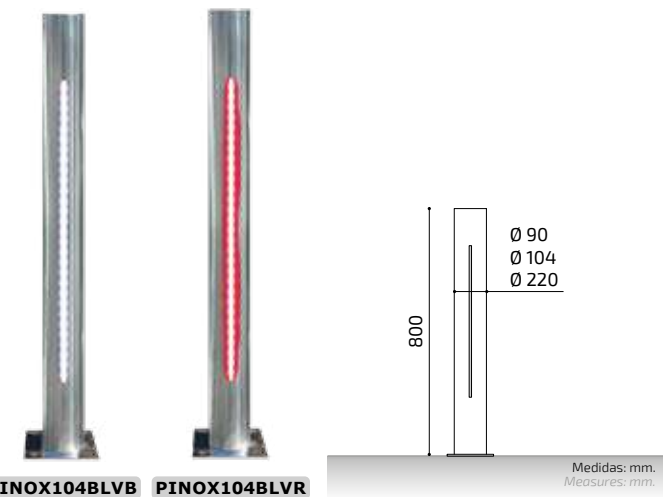

Bajo consumo 12v.
Low-energy 12v.

OLD LED

ACERO CORTEN | STEEL CORTEN

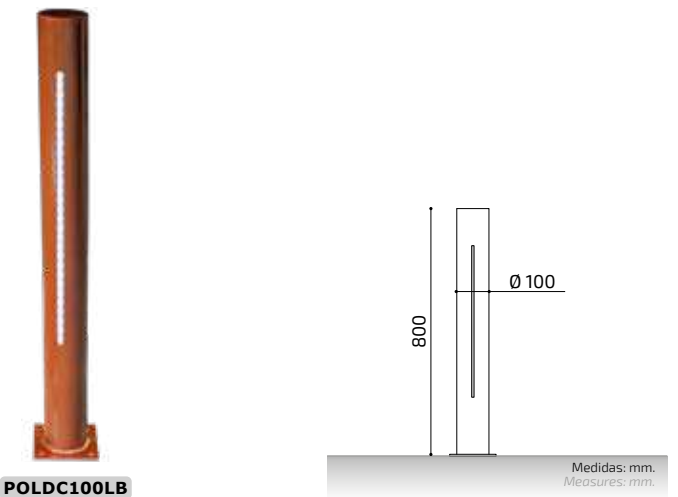

Bajo consumo 12v.
Low-energy 12v.



PILONAS LUMINOSAS CON LED FLEXIBLES Y SEMIFLEXIBLES FLEXIBLE AND SEMI FLEXIBLE LED LIGHT BOLLARDS

Pilona flexible luminosa con led en la parte superior pudiendo elegir color de led blanco ó led rojo, Otros colores y configuraciones a consultar (leds RGB), programación horaria, ...

Flexible light bollard with led on the top led color can be chosen between white and red. Other colors, settings (leds RGB) and time scheduling to be consulted.

A-FLEX LEDS

PLÁSTICO POLIURETANO | POLYURETHANE PLASTIC

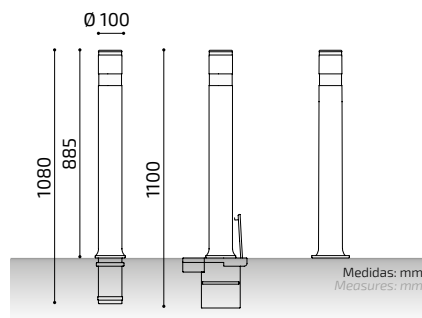

Flexibilidad 90°.
Flexibility 90°.



Posibilidad doble tira.
Double strip possibility.



Bajo consumo 12v.
Low-energy 12v.

A-ECO LEDS

PLÁSTICO POLIPROPILENO | POLYPROPYLENE PLASTIC

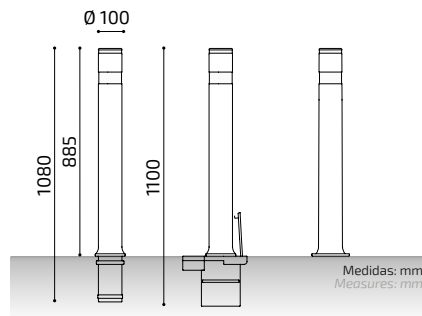

Flexibilidad limitada.
Limited flexibility.



Posibilidad doble tira.
Double strip possibility.



Bajo consumo 12v.
Low-energy 12v.

Barrera Abatible | Fold Down Barrier

BAM

HIERRO GALVANIZADO | GALVANIZED IRON

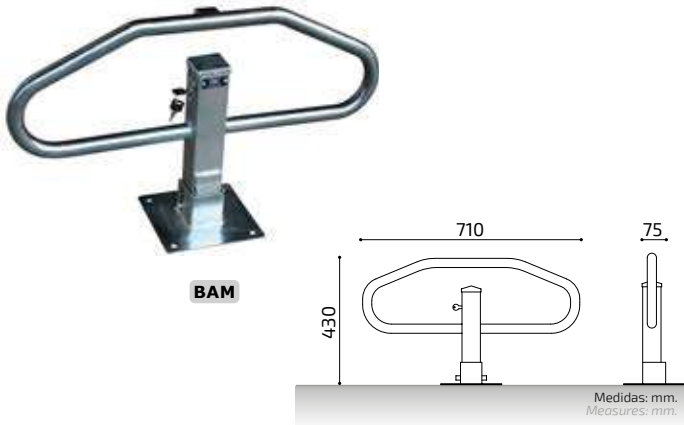

 Candado.
Padlock.

 Opcional llave igualada.
Optional matched key.

Barrera Abatible | Fold Down Barrier

RODAS

HIERRO GALVANIZADO | GALVANIZED IRON

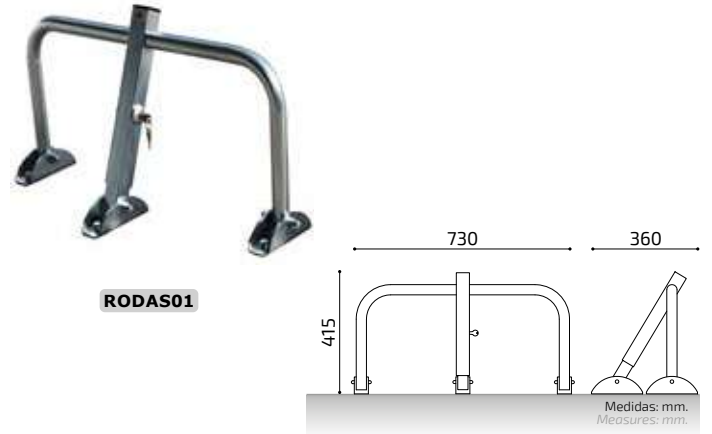

 Candado.
Padlock.

 Opcional llave igualada.
Optional matched key.

Barrera Abatible | Fold Down Barrier

VOLOS

HIERRO GALVANIZADO | GALVANIZED IRON

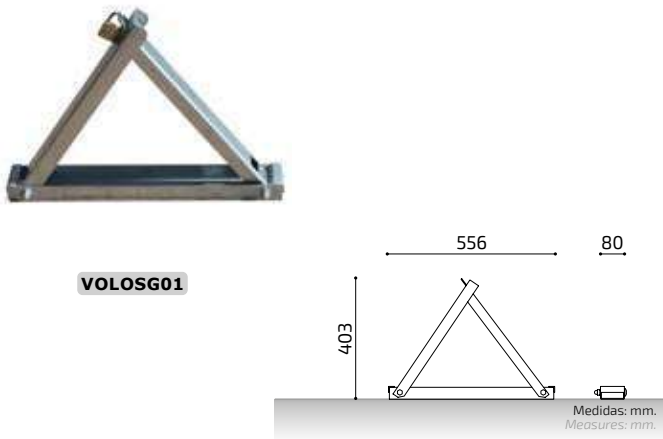

 Candado.
Padlock.

Pilona Abatible | Fold Down Barrier

TROYA

HIERRO | IRON

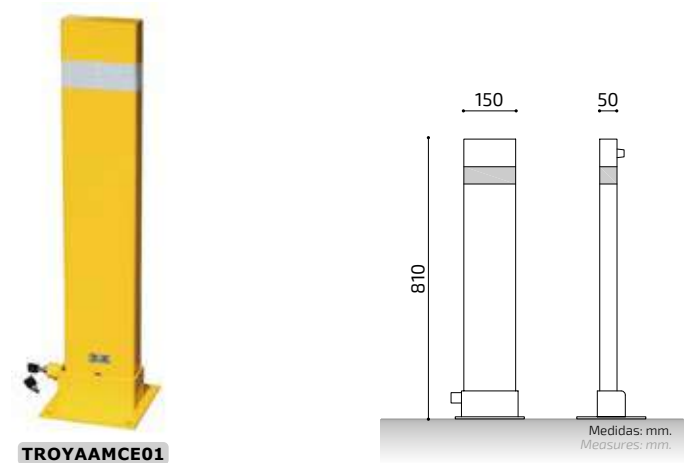

 Candado.
Padlock.

 Cerradura.
Lock.

 Opcional llave igualada.
Optional matched key.

Pilona Abatible | Fold Down Barrier

POMPEYA

HIERRO | IRON

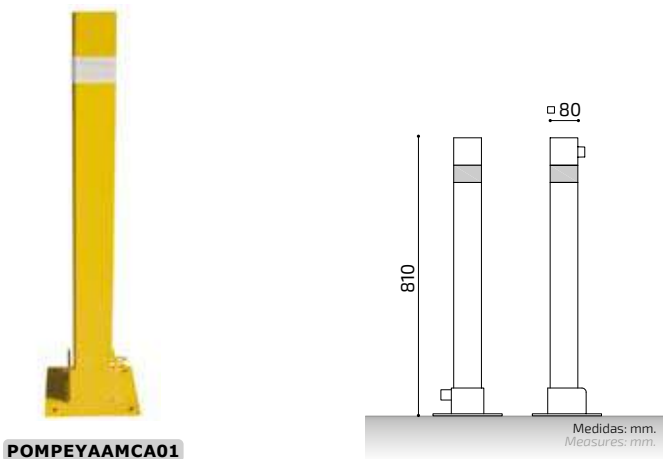

 Candado.
Padlock.

 Cerradura.
Lock.

 Opcional llave igualada.
Optional matched key.

Pilona Abatible | Fold Down Barrier

ATENAS

HIERRO | IRON

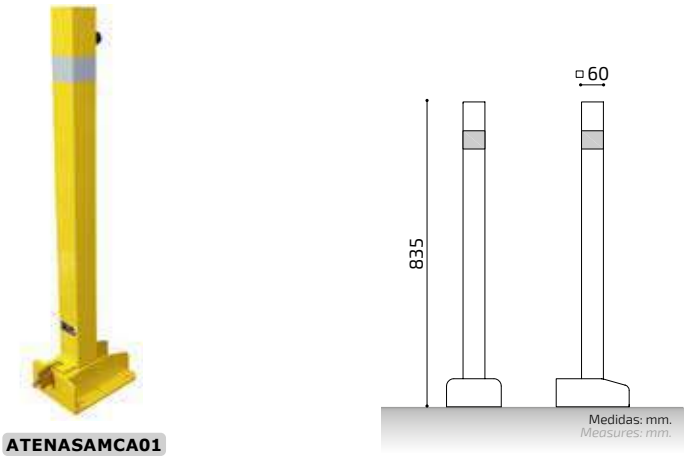

 Candado.
Padlock.

Pilona Abatible | *Fold Down Barrier*

FOLD

HIERRO | IRON



FOLDGCE01

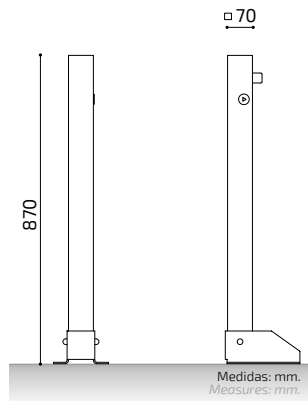

Medidas: mm.
Measures: mm.

Candado.
Padlock.

Pilona Abatible | *Fold Down Bollard*

STC / STC A-FLEX

PILONA | PILONA FLEXIBLE
BOLLARD | FLEXIBLE BOLLARDS

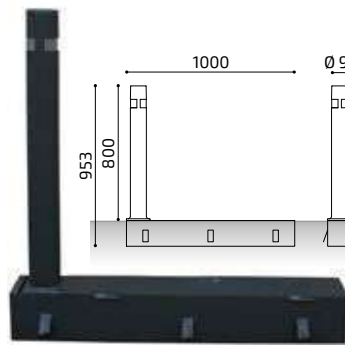

PILONASTC

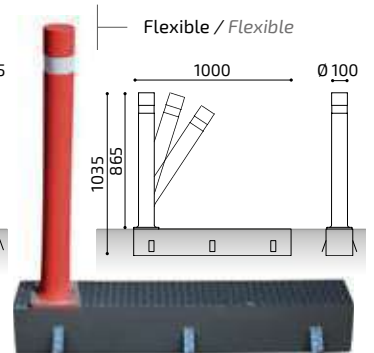

PILONASTC-A

Barrera | *Barrier*

GIRATORIA ECO

HIERRO | IRON

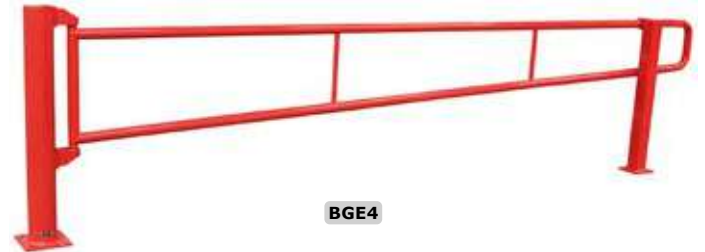

BGE4

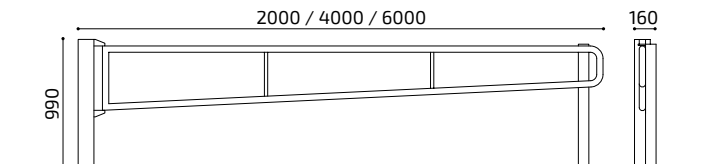

Medidas: mm.
Measures: mm.

Barrera | *Barrier*

GIRATORIA

HIERRO | IRON

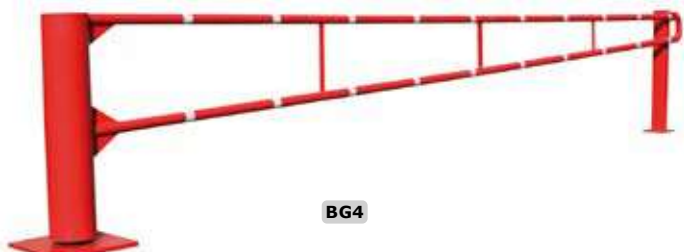

BG4

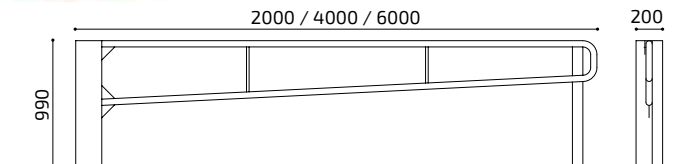

Medidas: mm.
Measures: mm.

Barrera | *Barrier*

GIRATORIA BMGC

HIERRO | IRON

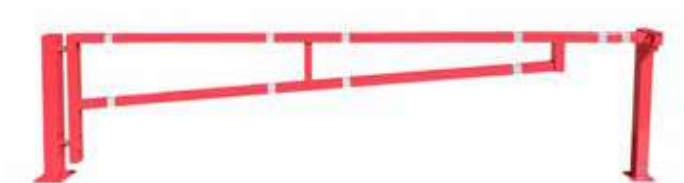

BMGC4

ABG

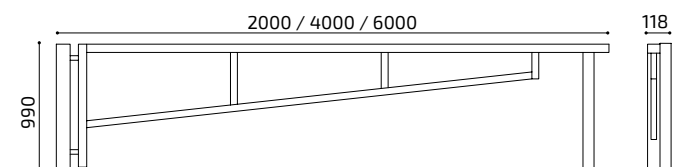

Medidas: mm.
Measures: mm.

Barrera | *Barrier*

ELEVABLE BM6

HIERRO | IRON



BM6

ABM6

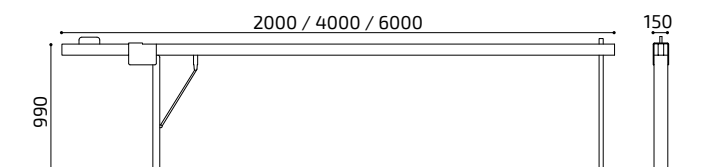

Medidas: mm.
Measures: mm.



BANCOS DE PLÁSTICO Y MADERA / PLASTIC AND WOOD BENCHES

Bancos construidos con patas de gran resistencia en plástico reciclable. Tratamiento ultravioleta. Listones de madera tropical.

Benches built with highly resistant legs made of recyclable plastic. UV treatment. Tropical Wood slats.

DAWN



MADERA • PLÁSTICO | WOOD • PLASTIC

Banco / Bench Silla / Chair



BDAWNP01



SDAWNP01

Patas plástico reciclable
Recyclable plastic legs
Plástico de gran calidad
High quality plastic

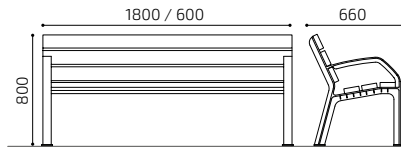

Medidas: mm.
Measures: mm.

NIGHTFALL



MADERA • PLÁSTICO | WOOD • PLASTIC

Banco / Bench Silla / Chair



BNIGHTFALLP01



SNIGHTFALLP01

Patas plástico reciclable
Recyclable plastic legs
Plástico de gran calidad
High quality plastic

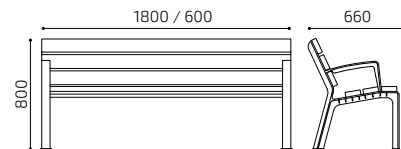

Medidas: mm.
Measures: mm.

LOA

MADERA • HIERRO • CORTEN • INOX. | WOOD • IRON • CORTEN • STAINLESS STEEL

Banco / Bench Silla / Chair



BLOAG01



SLOAG01

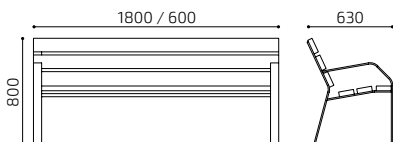

Medidas: mm.
Measures: mm.

ESTROFA

MADERA • HIERRO • CORTEN • INOX. | WOOD • IRON • CORTEN • STAINLESS STEEL

Banco / Bench Silla / Chair



BESTROFAG01



SESTROFAG01

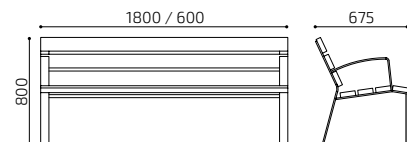

Medidas: mm.
Measures: mm.

ESTILO

MADERA • HIERRO • CORTEN • INOX. | WOOD • IRON • CORTEN • STAINLESS STEEL

 Banco / Bench  Silla / Chair



BESTILOG01



SESTILOG01

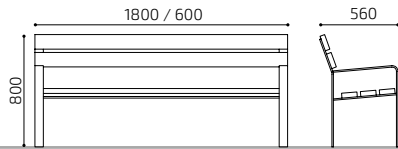

Medidas: mm.
Measures: mm.

ACORDE

MADERA • HIERRO • CORTEN • INOX. | WOOD • IRON • CORTEN • STAINLESS STEEL

 Banco / Bench  Silla / Chair



BACORDEG01



SACORDEG01

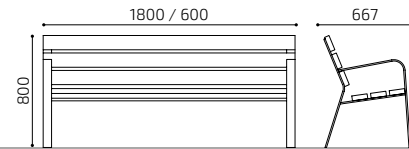

Medidas: mm.
Measures: mm.



DAMA

MADERA • HIERRO • CORTEN • INOX. | WOOD • IRON • CORTEN • STAINLESS STEEL

 Banco / Bench  Silla / Chair



BDAMAG01



SDAMAG01

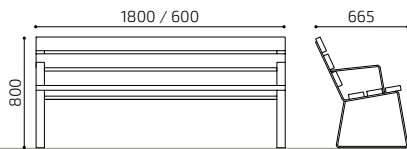

Medidas: mm.
Measures: mm.

NOTE

MADERA • HIERRO • CORTEN • INOX. | WOOD • IRON • CORTEN • STAINLESS STEEL

 Banco / Bench  Silla / Chair



BNOTEG01



SNOTEG01

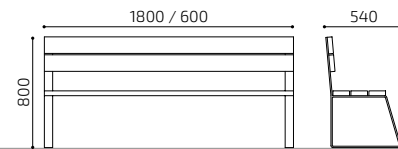

Medidas: mm.
Measures: mm.

UNAMUNO

MADERA • HIERRO • CORTEN • INOX. | WOOD • IRON • CORTEN • STAINLESS STEEL

 Banco / Bench  Silla / Chair



BUNAMUNOG01



SUNAMUNOG01

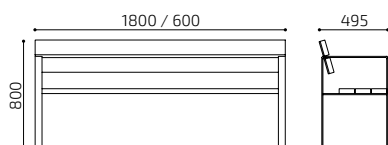

Medidas: mm.
Measures: mm.

HIMNO

MADERA • HIERRO • CORTEN • INOX. | WOOD • IRON • CORTEN • STAINLESS STEEL

 Banco / Bench  Silla / Chair



BHIMNOG01



SHIMNOG01

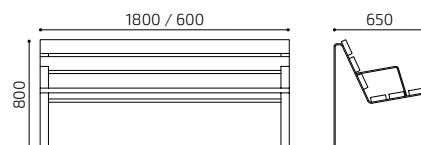

Medidas: mm.
Measures: mm.

LORCA

MADERA • HIERRO • CORTEN • INOX. | WOOD • IRON • CORTEN • STAINLESS STEEL

 Banco / Bench  Silla / Chair



BLORCAG01

SLORCAG01

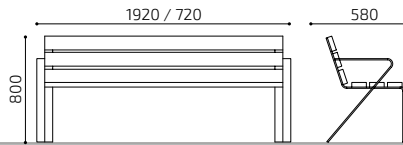

Medidas: mm.
Measures: mm.

CERVANTES

MADERA • HIERRO • CORTEN • INOX. | WOOD • IRON • CORTEN • STAINLESS STEEL

 Banco / Bench  Silla / Chair



BCERVANTESG01

SCERVANTESG01

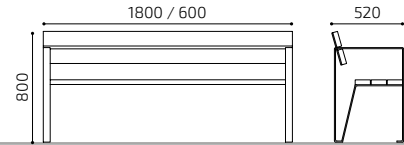

Medidas: mm.
Measures: mm.

VERSO

MADERA • HIERRO • CORTEN • INOX. | WOOD • IRON • CORTEN • STAINLESS STEEL

 Banco / Bench  Silla / Chair  Banqueta / Low bench



BVERSOIC

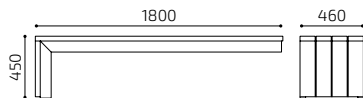

Medidas: mm.
Measures: mm.

PROSA

MADERA • HIERRO • CORTEN • INOX. | WOOD • IRON • CORTEN • STAINLESS STEEL

 Banco / Bench  Silla / Chair  Banqueta / Low bench



BPROSAG01

SPROSAG01

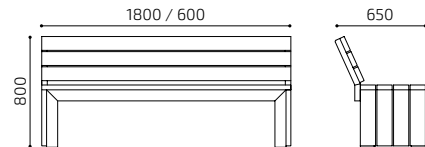

Medidas: mm.
Measures: mm.

TEATRO

MADERA • HIERRO • CORTEN • INOX. | WOOD • IRON • CORTEN • STAINLESS STEEL

 Banco / Bench  Silla / Chair  Banqueta / Low bench



BTEATROC01

STEATROC01

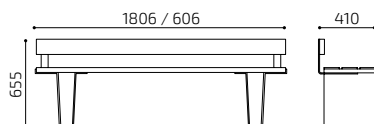

Medidas: mm.
Measures: mm.



DICKENS

MADERA • HIERRO • CORTEN • INOX. | WOOD • IRON • CORTEN • STAINLESS STEEL

 Banco / Bench  Silla / Chair  Banqueta / Low bench



BDICKENSG01

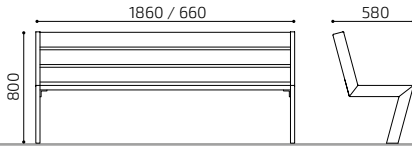

Medidas: mm.
Measures: mm.

ORIGAMI

MADERA • HIERRO • CORTEN • INOX. | WOOD • IRON • CORTEN • STAINLESS STEEL

 Banco / Bench  Silla / Chair  Banqueta / Low bench



BORIGAMIG01

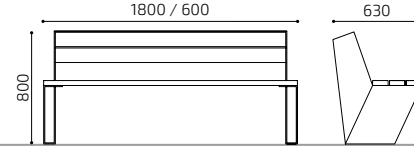
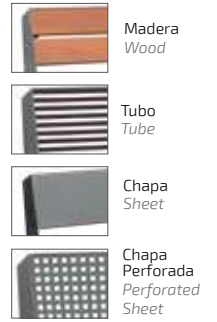

Medidas: mm.
Measures: mm.

NOVELA

MADERA • HIERRO • CORTEN • INOX. | WOOD • IRON • CORTEN • STAINLESS STEEL

 Banco / Bench  Silla / Chair  Banqueta / Low bench



BNOVELAI01

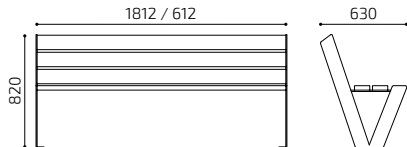

Medidas: mm.
Measures: mm.

POESIA

MADERA • HIERRO • CORTEN • INOX. | WOOD • IRON • CORTEN • STAINLESS STEEL

 Banco / Bench  Silla / Chair  Banqueta / Low bench



BPOESIAG01

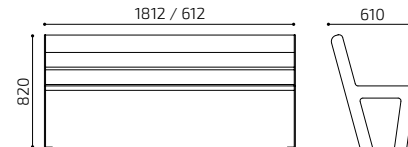

Medidas: mm.
Measures: mm.

LEYEND

MADERA • HIERRO • CORTEN • INOX. | WOOD • IRON • CORTEN • STAINLESS STEEL

 Banco / Bench  Silla / Chair  Banqueta / Low bench



BLEYENDG01

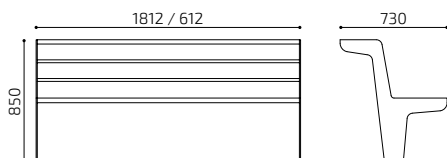
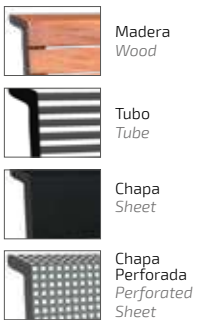

Medidas: mm.
Measures: mm.

GALA

MADERA • HIERRO • CORTEN • INOX. | WOOD • IRON • CORTEN • STAINLESS STEEL

 Banco / Bench  Silla / Chair  Banqueta / Low bench



BGALAG01

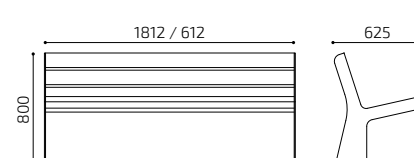

Medidas: mm.
Measures: mm.



ENTE

MADERA • HIERRO • CORTEN • INOX. | WOOD • IRON • CORTEN • STAINLESS STEEL

Banco / Bench Silla / Chair Banqueta / Low bench



BENTEG01

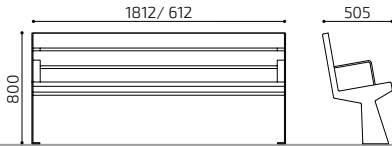

Medidas: mm.
Measures: mm.

ENERRE

MADERA • HIERRO • CORTEN • INOX. | WOOD • IRON • CORTEN • STAINLESS STEEL

Banco / Bench Silla / Chair Banqueta / Low bench



BENERREG01

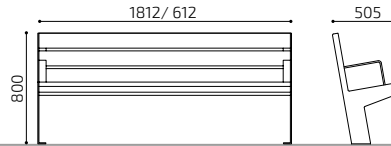

Medidas: mm.
Measures: mm.

SADE

HIERRO • CORTEN • INOX. | IRON • CORTEN • STAINLESS STEEL

Banco / Bench Silla / Chair Banqueta / Low bench



BSADEG01

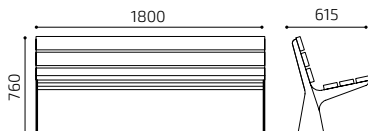

Medidas: mm.
Measures: mm.

VERNE

MADERA • HIERRO • CORTEN • INOX. | WOOD • IRON • CORTEN • STAINLESS STEEL

Banco / Bench



BVERNEG01

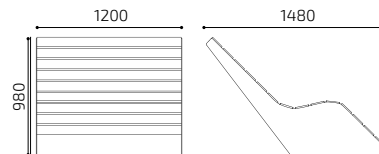

Medidas: mm.
Measures: mm.

MISTRAL

MADERA • HIERRO • CORTEN • INOX. | WOOD • IRON • CORTEN • STAINLESS STEEL

Banqueta / Low bench



BMISTRALG01

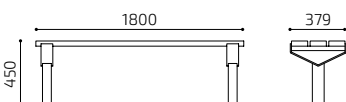

Medidas: mm.
Measures: mm.

ALLENDE

MADERA • HIERRO • CORTEN • INOX. | WOOD • IRON • CORTEN • STAINLESS STEEL

Banqueta / Low bench



BALLENEG01

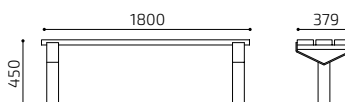
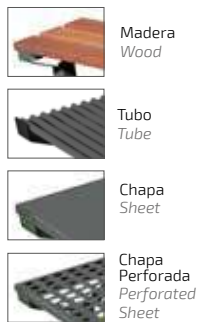

Medidas: mm.
Measures: mm.



EPICA

MADERA • HIERRO • CORTEN • INOX. | WOOD • IRON • CORTEN • STAINLESS STEEL

Banqueta / Low bench



BEPICA02

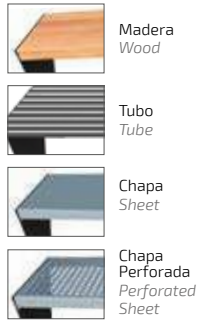

Medidas: mm.
Measures: mm.

SQUARED

MADERA • HIERRO • CORTEN • INOX. | WOOD • IRON • CORTEN • STAINLESS STEEL

Banqueta / Low bench



BSQUAREDG01

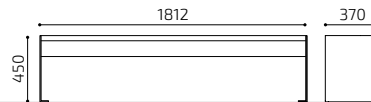
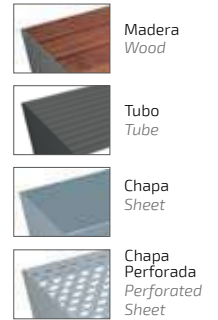

Medidas: mm.
Measures: mm.

TALI

MADERA • HIERRO • CORTEN • INOX. | WOOD • IRON • CORTEN • STAINLESS STEEL

Banqueta / Low bench



BTALIG02

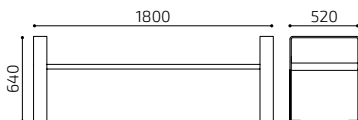

Medidas: mm.
Measures: mm.

VARGAS

MADERA • HIERRO • CORTEN • INOX. | WOOD • IRON • CORTEN • STAINLESS STEEL

Banqueta / Low bench



BVARGASG01

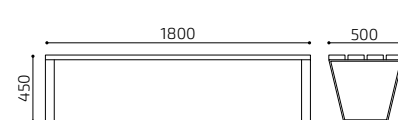

Medidas: mm.
Measures: mm.

FLEX

HIERRO • CORTEN • INOX. | IRON • CORTEN • STAINLESS STEEL

Banco / Bench Silla / Chair



BFLEXG01



SFLEXG01

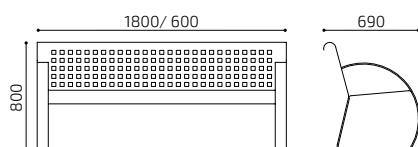

Medidas: mm.
Measures: mm.

FASO

HIERRO • CORTEN • INOX. | IRON • CORTEN • STAINLESS STEEL

Banco / Bench Silla / Chair



BFASOG01



SFASOG01

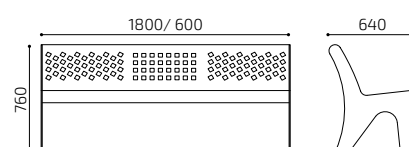

Medidas: mm.
Measures: mm.



BOOK

MADERA • CORTEN • INOX. | WOOD • CORTEN • STAINLESS STEEL



Banco / Bench Silla / Chair Banqueta / Low bench



BBOOKC02

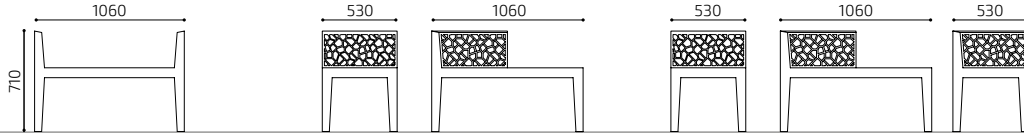

* Sin respaldo / Backless.

* Con respaldo / With Backup.

* Con 2 respaldos / With 2 Backs.

Medidas: mm.
Measures: mm.

GARDEN

MADERA • HIERRO • CORTEN • INOX. | WOOD • IRON • CORTEN • STAINLESS STEEL

Mesa picnic / Picnic table



BGARDENG01

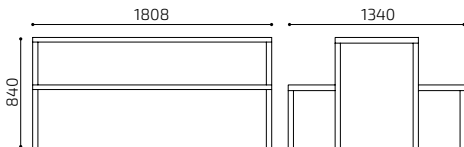

Medidas: mm.
Measures: mm.

PICNIC

MADERA • HIERRO • CORTEN • INOX. | WOOD • IRON • CORTEN • STAINLESS STEEL

Mesa picnic / Picnic table



BPICNICG01

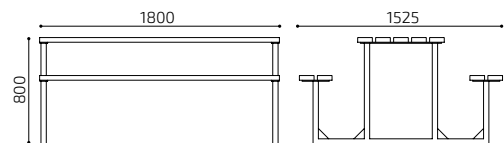
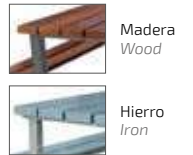

Medidas: mm.
Measures: mm.

STRONG

MADERA • HIERRO • CORTEN • INOX. | WOOD • IRON • CORTEN • STAINLESS STEEL

Mesa picnic / Picnic table



BSTRONG01

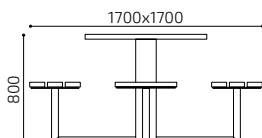
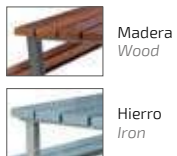

Medidas: mm.
Measures: mm.

OCIO

MADERA • HIERRO • CORTEN • INOX. | WOOD • IRON • CORTEN • STAINLESS STEEL

Mesa picnic / Picnic table



BOCI0G01

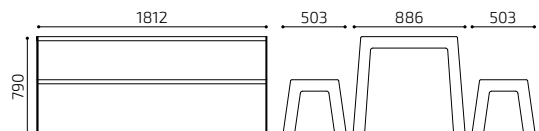

Medidas: mm.
Measures: mm.

MESAS PICNIC | PICNIC TABLES

JORVI

MADERA | WOOD

Mesa picnic / Picnic table



Picnic gama premium
Picnic premium range

JORVI

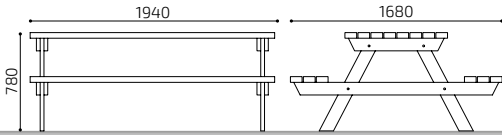

Medidas: mm.
Measures: mm.

SILVESTRE

MADERA | WOOD

Mesa picnic / Picnic table



Picnic gama eco
Picnic eco range

MSILVESTRE

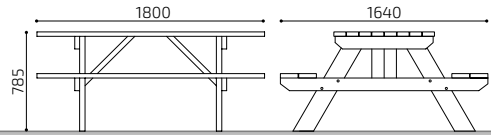

Medidas: mm.
Measures: mm.

APOYO

MADERA • HIERRO • CORTEN • INOX. | WOOD • IRON • CORTEN • STAINLESS STEEL

Banco / Bench



BAPOYOI01

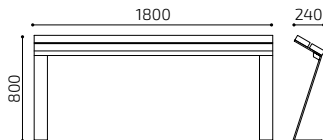

Medidas: mm.
Measures: mm.

REPOSO

HIERRO • CORTEN • INOX. | IRON • CORTEN • STAINLESS STEEL

Banco / Bench



BREPOSOG01

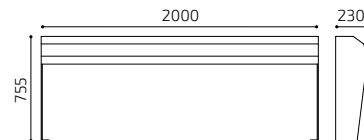

Medidas: mm.
Measures: mm.



BANCOS DE HORMIGÓN / CONCRETE BENCHES

HORMIGÓN | CONCRETE



Cube



Prisma



Trinix



DISEÑOS A MEDIDA / CUSTOMIZED DESIGNS

MADERA • HIERRO • CORTEN • INOX. | WOOD • IRON • CORTEN • STAINLESS STEEL



UNIVERSAL

HIERRO GALVANIZADO • CORTEN • INOX. | GALVANIZED I. • CORTEN • STAINLESS STEEL

Unidad / Unit |  2

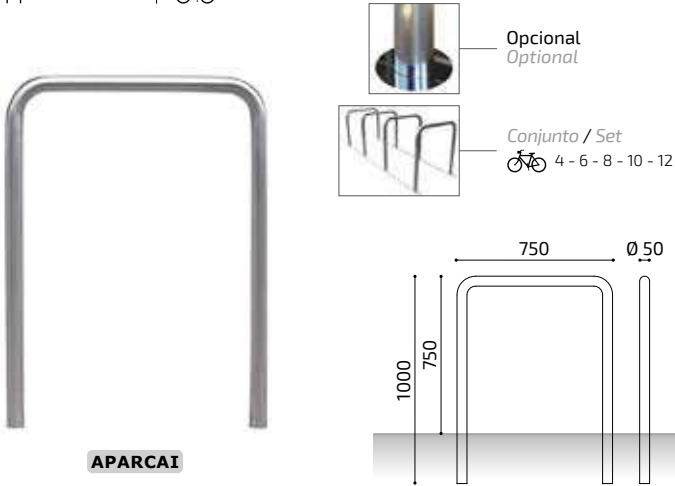

Bajo pedido AISI 316. / By request AISI 316.

ARRA

HIERRO GALVANIZADO • CORTEN • INOX. | GALVANIZED I. • CORTEN • STAINLESS STEEL

Unidad / Unit |  2



Bajo pedido AISI 316. / By request AISI 316.

ROTUL

HIERRO GALVANIZADO • CORTEN • INOX. | GALVANIZED I. • CORTEN • STAINLESS STEEL

Unidad / Unit |  2

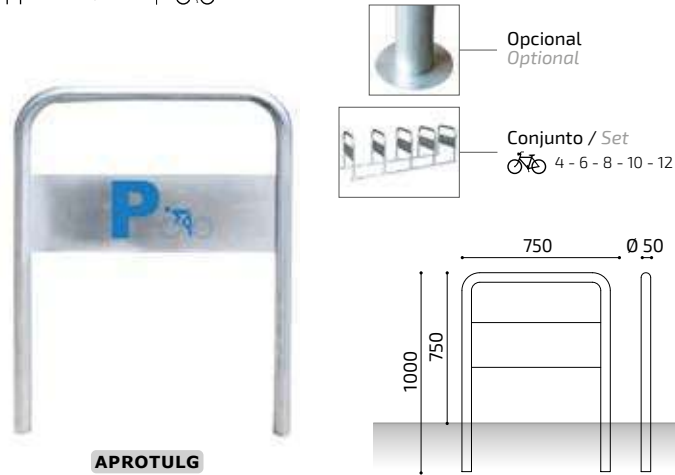

Bajo pedido AISI 316. / By request AISI 316.

PLETI

HIERRO GALVANIZADO • CORTEN • INOX. | GALVANIZED I. • CORTEN • STAINLESS STEEL

Unidad / Unit |  2

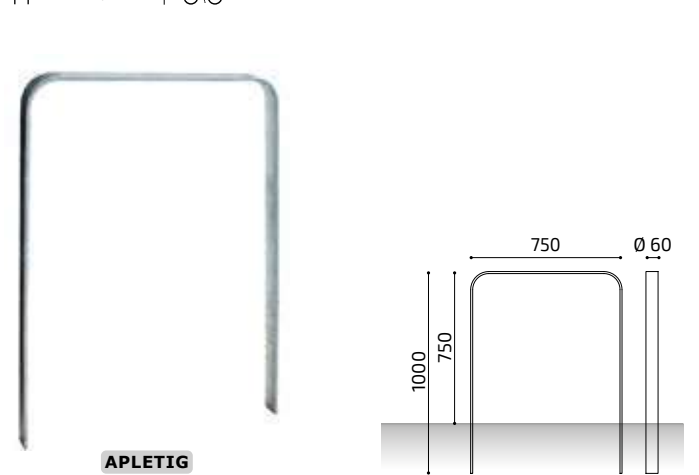

Bajo pedido AISI 316. / By request AISI 316.

MODUL

HIERRO GALVANIZADO | GALVANIZED IRON

Conjunto / Set |  6

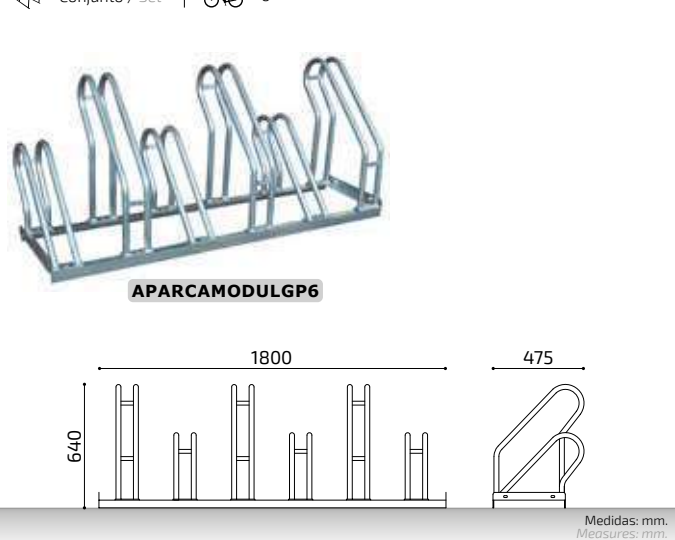

UVE

HIERRO GALVANIZADO | GALVANIZED IRON

Conjunto / Set |  6

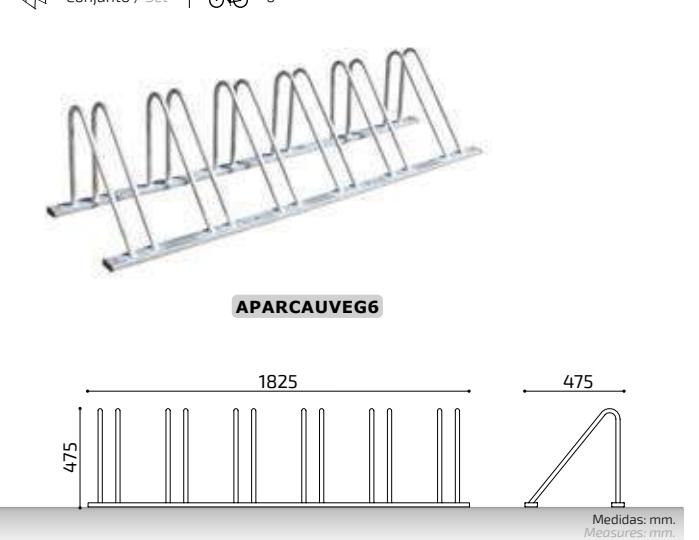

NOR

HIERRO GALVANIZADO • INOX. | GALVANIZED I. • STAINLESS STEEL

Conjunto / Set |  6

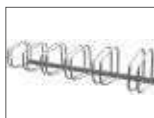

Fijación a suelo o a pared
Fixing to floor or wall

APARCANORG6

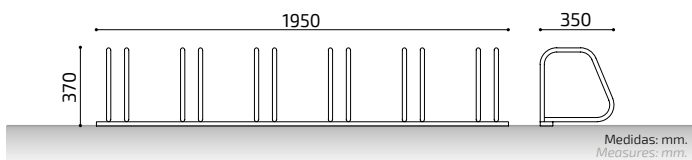

Bajo pedido AISI 316. / By request AISI 316.

PLEC / CLEC

HIERRO • CORTEN | IRON • CORTEN STEEL

Conjunto / Set |  4

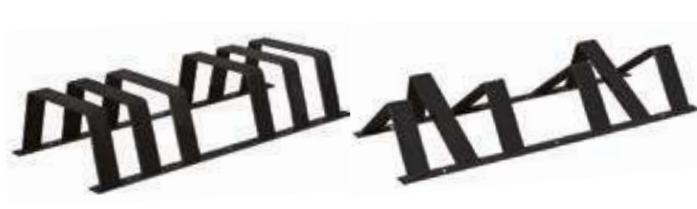

APPLECH4

APCLECH4

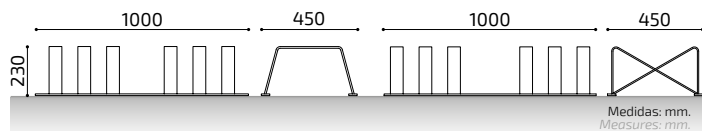

TWISTER

H. GALVANIZADO • CORTEN | GALVANIZED I. • CORTEN

Conjunto / Set |  20



APARCATWISTEROG01

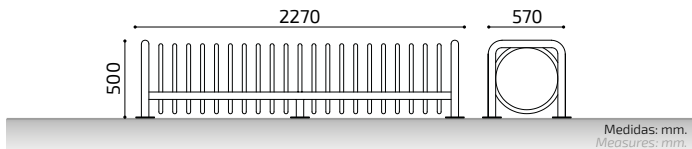

SNAKE

H. GALVANIZADO • CORTEN • INOX. | GALVANIZED I. • CORTEN • STAINLESS STEEL

Conjunto / Set |  7



APARCASNAKEIP7

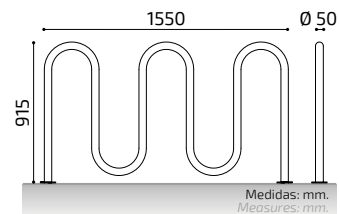

Bajo pedido AISI 316. / By request AISI 316.

ARI

ACERO INOX. | STAINLESS STEEL

Unidad / Unit |  2



Opcional
Optional



Conjunto / Set
 4 - 6 - 8 - 10 - 12



ARI304

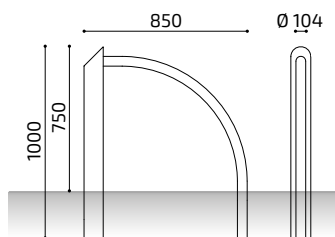

Bajo pedido AISI 316. / By request AISI 316.

OLA

ACERO INOX. | STAINLESS STEEL

Unidad / Unit |  2



Opcional
Optional



Conjunto / Set
 4 - 6 - 8 - 10 - 12



OLA304

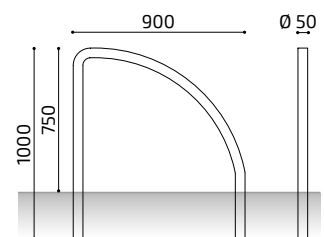

Bajo pedido AISI 316. / By request AISI 316.



TOTEM

HIERRO GALVANIZADO • CORTEN | GALVANIZED IRON • CORTEN STEEL

Unidad / Unit |  2



APTOTEMG01

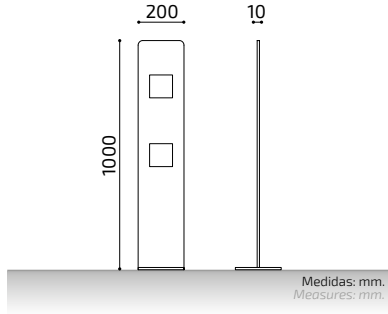

CAPE

HIERRO GALVANIZADO | GALVANIZED IRON

Unidad / Unit |  2



APCAPE01

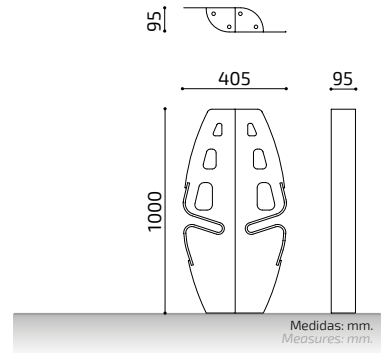

FOUR

ADO
design

HIERRO GALVANIZADO • CORTEN • INOX. | GALVANIZED I. • CORTEN • STAINLESS STEEL

Unidad / Unit |  2



APARCAFOURI304P

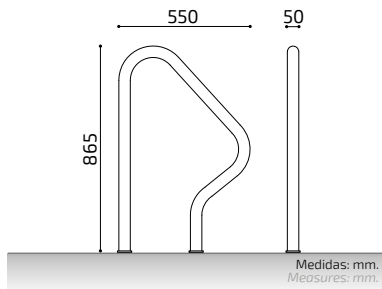

URANO

H. GALVANIZADO • CORTEN • INOX. | GALVANIZED I. • CORTEN • STAINLESS STEEL

Unidad / Unit |  2



APURANOP304

APURANOCOP

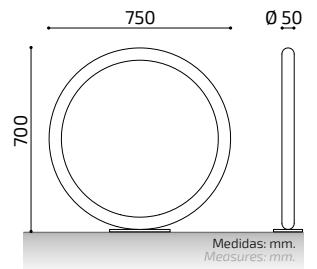

Bajo pedido AISI 316. / By request AISI 316.

Bajo pedido AISI 316. / By request AISI 316.

NEPTUNO

H. GALVANIZADO • CORTEN • INOX. | GALVANIZED I. • CORTEN • STAINLESS STEEL

Unidad / Unit |  2



APNEPTUNOP304

APNEPTUNOCOP

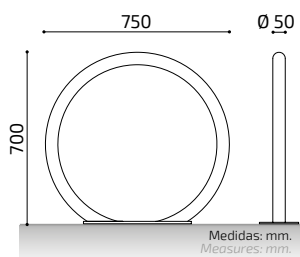

VILA

H. GALVANIZADO • CORTEN • HIERRO | GALVANIZED I. • CORTEN • IRON

Unidad / Unit |  2



APVILAG01

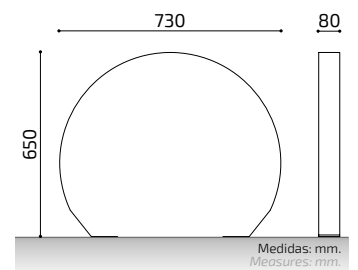

Bajo pedido AISI 316. / By request AISI 316.

Bajo pedido AISI 316. / By request AISI 316.

PARÍS / MARSELLA

HIERRO • CORTEN | IRON • CORTEN STEEL

Unidad / Unit |  1



APBPRO

APBMCO

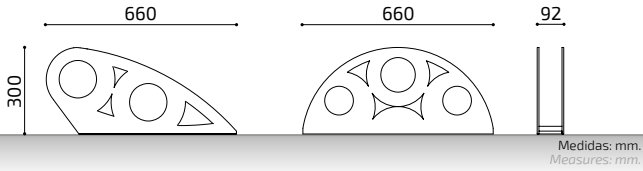

Medidas: mm.
Measures: mm.

LETTER

H. GALVANIZADO • CORTEN • INOX. | GALVANIZED I. • CORTEN • STAINLESS STEEL

Conjunto / Set |  8

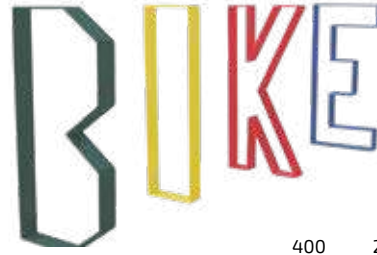

Letras según diseño
Custom Lettering

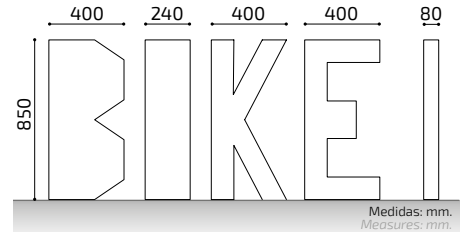

Medidas: mm.
Measures: mm.

Taquilla aparcá bicicletas plegables / patinetes

Folding bike and scooter parking locker

CAGE

HIERRO | IRON



TAQBICI



Cerradura codificada por contraseña electrónica digital de apertura-cierre mediante combinación numérica.
Lock coded by digital electronic password for opening-closing by means of a numerical combination.

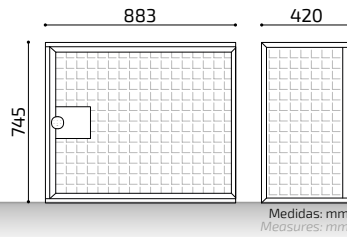

Medidas: mm.
Measures: mm.



BIKE

HIERRO GALVANIZADO • CORTEN • ACERO INOX. | GALVANIZED IRON • CORTEN STEEL • STAINLESS STEEL



APARCABIKEI304P



APARCABIKEI304P2



APARCABIKEI304P4

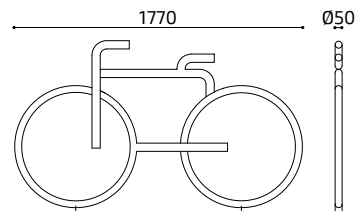
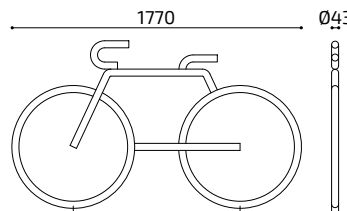
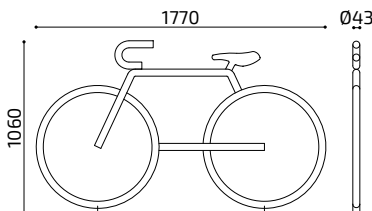

Medidas: mm.
Measures: mm.

Estación mantenimiento Bicicletas

Bike repair station

KEEPER

ACERO INOXIDABLE • HIERRO | STAINLESS STEEL • IRON



Opcional
Optional

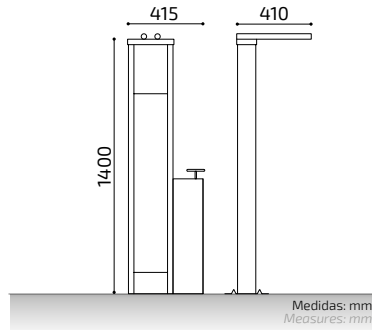

FLOOR

HIERRO | IRON

Unidad / Unit | 1

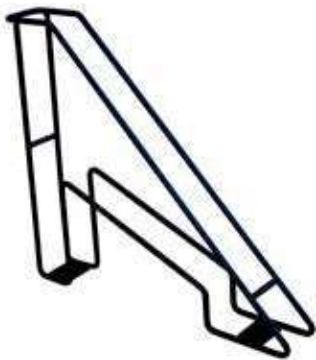

AFLOORHN

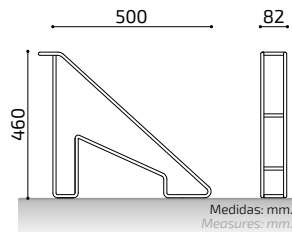

WALL

HIERRO | IRON

Unidad / Unit | 1



AWALLHN

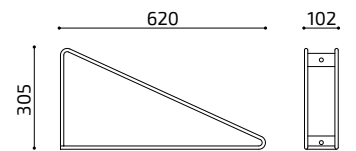

Soporte Suelo | Floor Bracket

FOREST

HIERRO + MADERA | IRON + WOOD



AFORESTHR

AFORESTHN

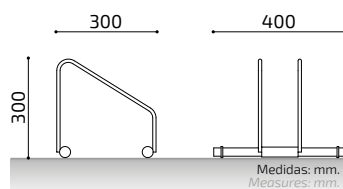

Soporte Pared | Wall Bracket

KONG

HIERRO | IRON



KONGBR01

KONGGN01

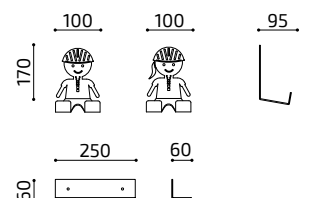

E-SCOOTER

HIERRO GALVANIZADO • INOX. | GALVANIZED IRON • STAINLESS STEEL

5 - 8 - 11



A	B	C
1000	200	900
1500	200	900
1900	200	900

APSCOOTERG2.0PE

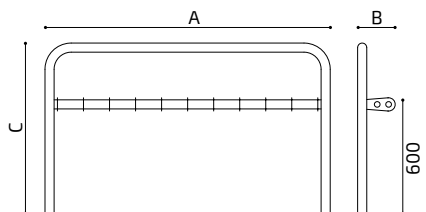

Medidas: mm.
Measures: mm.

Bajo pedido AISI 316. / By request AISI 316.

E-SCHOOL

HIERRO GALVANIZADO • INOX. | GALVANIZED IRON • STAINLESS STEEL

4 - 7 - 10



A	B	C
1000	200	600
1500	200	600
1900	200	600

APSCHOOLG1.5PE

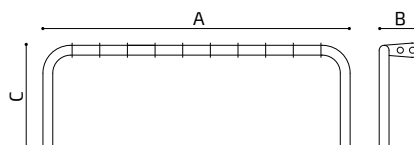

Medidas: mm.
Measures: mm.

Bajo pedido AISI 316. / By request AISI 316.

E-SKATER

HIERRO GALVANIZADO • INOX. | GALVANIZED IRON • STAINLESS STEEL

6 - 9 - 11



A	B	C
1000	230	900
1500	230	900
1900	230	900

APSKATERG1.5PE

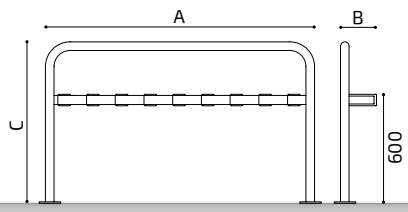

Medidas: mm.
Measures: mm.

Bajo pedido AISI 316. / By request AISI 316.

E-ROLLER

HIERRO GALVANIZADO • INOX. | GALVANIZED IRON • STAINLESS STEEL

5 - 8 - 10



A	B	C
1000	230	600
1500	230	600
1900	230	600

APROLLERG1.5PE

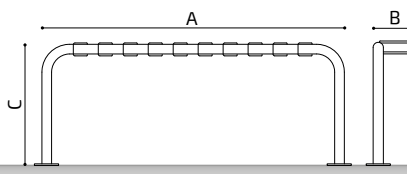

Medidas: mm.
Measures: mm.

Bajo pedido AISI 316. / By request AISI 316.

E-NUMBER

HIERRO GALVANIZADO • INOX. | GALVANIZED IRON • STAINLESS STEEL

4 - 6 - 8



APNUMBERG2.0PE



Cerradura codificada por contraseña electrónica digital de apertura-cierre mediante combinación numérica.

Lock coded by digital electronic password for opening-closing by means of a numerical combination.

A	B	C
1000	150	900
1500	150	900
1900	150	900

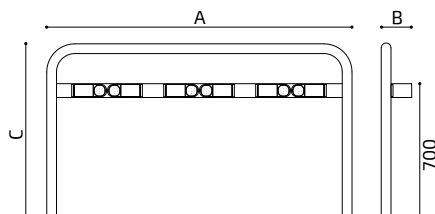

Medidas: mm.
Measures: mm.

Bajo pedido AISI 316. / By request AISI 316.



CIRCU

HIERRO • ACERO INOX. | IRON • STAINLESS STEEL



PAPEHIER60L



PAPEINOX60L

49L

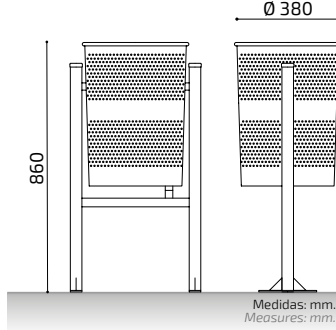

☑ Vaciado basculante. / Emptying tipping.

SEMICIRCU

HIERRO • ACERO INOX. | IRON • STAINLESS STEEL



PAPEHIERSEMI



PAPEINOXSEMI

33L

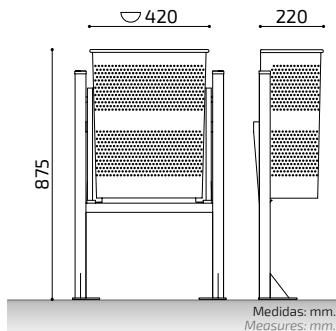

☑ Vaciado basculante. / Emptying tipping.

BARCELONA / BARCELONA DOBLE

HIERRO | IRON



PBARCE01

63L



PBARCE01D

126L



Llave de seguridad
Security key

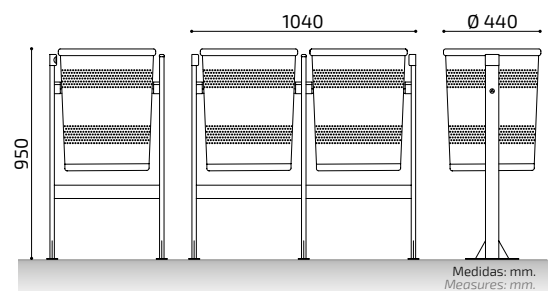

☑ Vaciado basculante. / Emptying tipping.

LIFE

HIERRO | IRON



47L

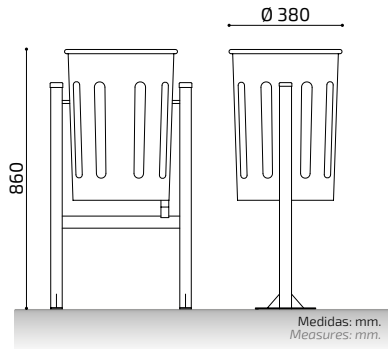

PLIFE01

Medidas: mm.
Measures: mm.

☑ Vaciado basculante. / Emptying tipping.

TENE

HIERRO | IRON



38L

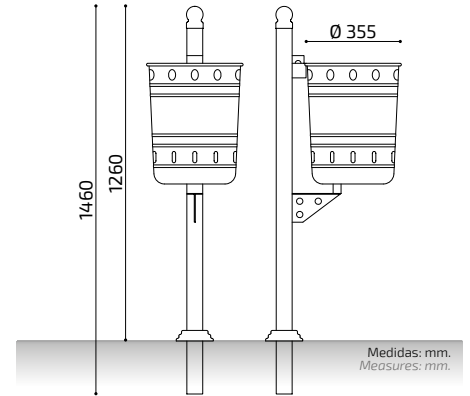

PTENE01

Medidas: mm.
Measures: mm.

☑ Vaciado basculante. / Emptying tipping.

DIM

HIERRO • CORTEN • INOX. | IRON • CORTEN STEEL • STAINLESS STEEL



50L

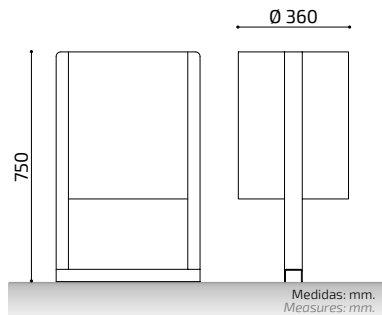

PDIMIG01

Medidas: mm.
Measures: mm.

RETO

HIERRO • CORTEN • INOX. | IRON • CORTEN STEEL • STAINLESS STEEL



50L

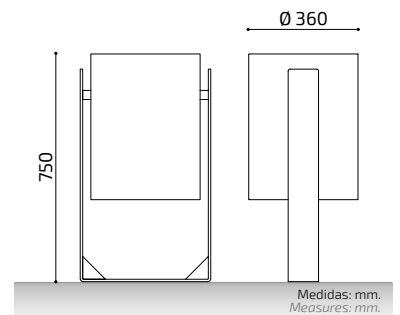

PRETO01

Medidas: mm.
Measures: mm.

☑ Vaciado basculante. / Emptying tipping.

TALI

HIERRO • CORTEN • INOX. | IRON • CORTEN STEEL • STAINLESS STEEL



42L

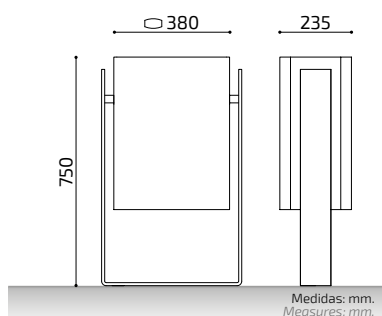

PTALIIC

Medidas: mm.
Measures: mm.

☑ Vaciado basculante. / Emptying tipping.

TALI PLUS

HIERRO • CORTEN • INOX. | IRON • CORTEN STEEL • STAINLESS STEEL



33L

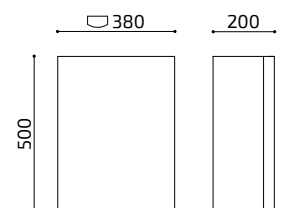

PTALIPI

Fijación a pared. / Fixing to wall.

SIME

HIERRO • CORTEN • INOX. | IRON • CORTEN STEEL • STAINLESS STEEL



PSIMEC01



Opcional: Cenicero
Optional: Ashtray

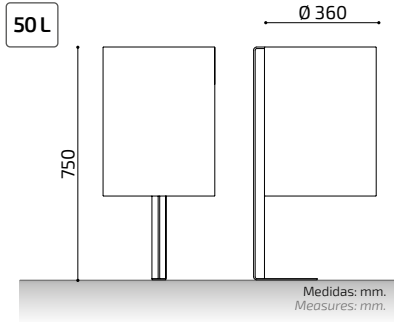

TRESTO

HIERRO • CORTEN • INOX. | IRON • CORTEN STEEL • STAINLESS



PTRESTO01



Opcional: Cenicero
Optional: Ashtray

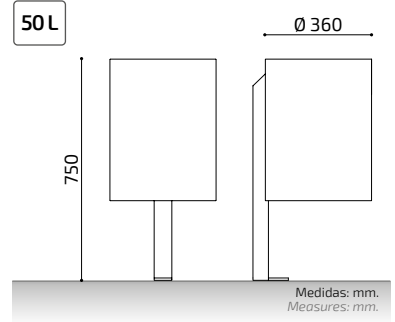

MALLEN

HIERRO • CORTEN • INOX. | IRON • CORTEN STEEL • STAINLESS



PMALLENC01



Opcional: Cenicero
Optional: Ashtray

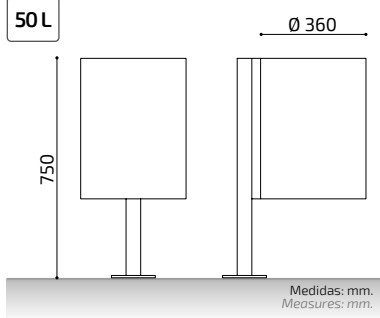

LUXOR

HIERRO • CORTEN | IRON • CORTEN STEEL



PLUXORC01

50 L

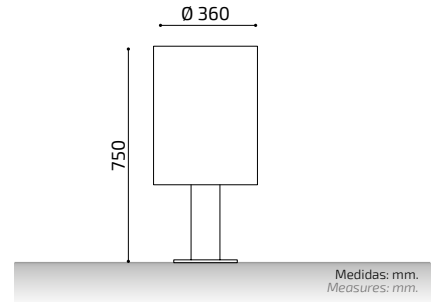

TRECEN

HIERRO • CORTEN | IRON • CORTEN STEEL



PTRECENC01

50 L

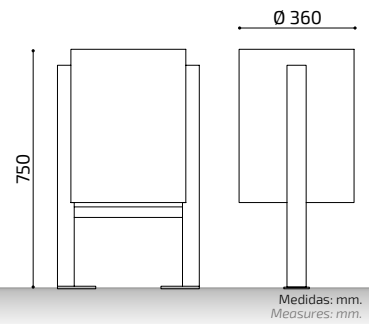

RUE

HIERRO • CORTEN | IRON • CORTEN STEEL



PRUEC01

50 L

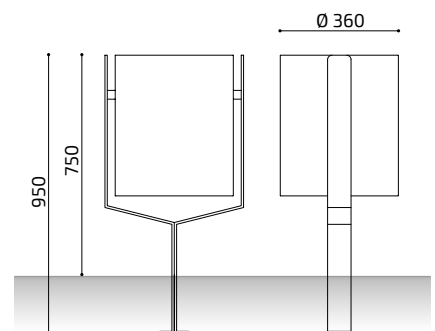

DEVA

HIERRO • CORTEN • INOX. | IRON • CORTEN STEEL • STAINLESS STEEL



92 L

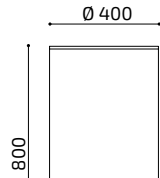

PDEVAG01

Medidas: mm.
Measures: mm.

NOK

HIERRO GALVANIZADO | GALVANIZED IRON



120 L

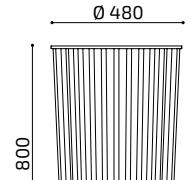

PNOKG01

Medidas: mm.
Measures: mm.

Opcional: Cubeta interior
Optional: Interior bucket

BEE

HIERRO GALVANIZADO • CORTEN | GALVANIZED IRON • CORTEN STEEL



87 L

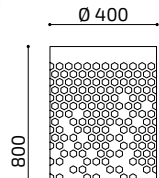

PBEEG01

Medidas: mm.
Measures: mm.

Opcional: Cubeta interior
Optional: Interior bucket

STONE

HIERRO • CORTEN | IRON • CORTEN STEEL



87 L

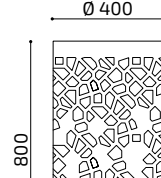

PSTONEC01

Medidas: mm.
Measures: mm.

Opcional: Cubeta interior
Optional: Interior bucket

LIVRE

H. GALVANIZADO • CORTEN • INOX. | GALVANIZED I. • CORTEN • STAINLESS STEEL



115 L

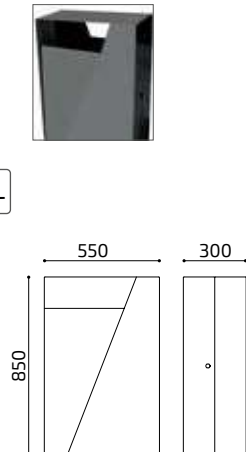

PLIVREC01

Medidas: mm.
Measures: mm.

BOITE

HIERRO • CORTEN • INOX. | IRON • CORTEN STEEL • STAINLESS STEEL



130 L

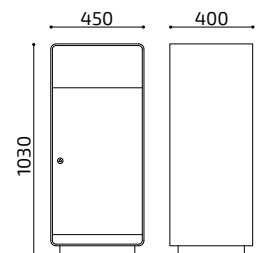

PBOITEG01

Medidas: mm.
Measures: mm.



ARCADIA

HIERRO GALVANIZADO • CORTEN | GALVANIZED IRON • CORTEN STEEL



103 L

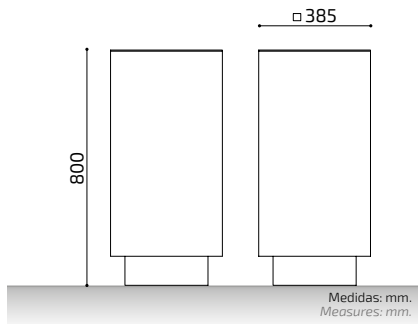

PARCADIAG01

Medidas: mm.
Measures: mm.

TEBAS

HIERRO GALVANIZADO • CORTEN | GALVANIZED IRON • CORTEN STEEL



96 L

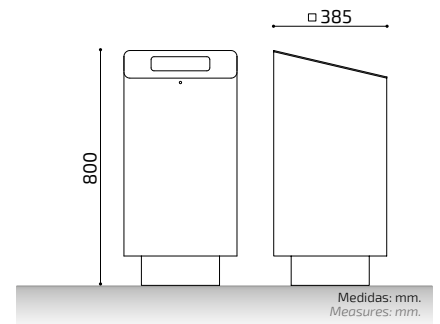

PTEBASG01

Medidas: mm.
Measures: mm.

EMI

ACERO INOX. | STAINLESS STEEL



66 L

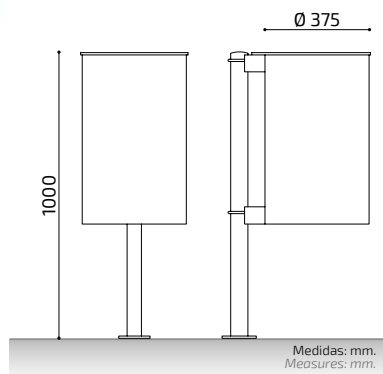

PEMI01

Medidas: mm.
Measures: mm.

DENLA

ACERO INOX. | STAINLESS STEEL



Posibilidad de anclaje a pared
Possibility of anchoring to wall

42 L

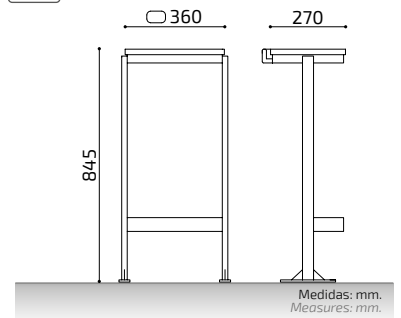

PDENLA

Medidas: mm.
Measures: mm.

Bajo pedido AISI 316. / By request AISI 316.

Bajo pedido AISI 316. / By request AISI 316.



BOX

H. GALVANIZADO • ACERO INOX. | GALVANIZED IRON • STAINLESS STEEL



Caja bolsas (10 rollos de 500 bolsas)
Bag box (10 rolls of 500 bags)
Tamaño bolsa / Bag size: 250x340
(No incluidas / Not included)

BEMUSI02

34 L

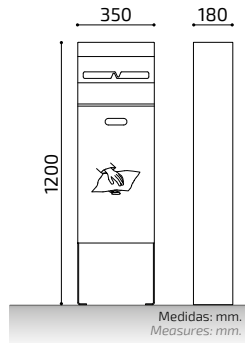

☑ Vaciado basculante. / Emptying tipping.

MUSI

H. GALVANIZADO • ACERO INOX. | GALVANIZED IRON • STAINLESS STEEL



Caja bolsas (10 rollos de 500 bolsas)
Bag box (10 rolls of 500 bags)
Tamaño bolsa / Bag size: 250x340
(No incluidas / Not included)

BEMUSI02

27 L

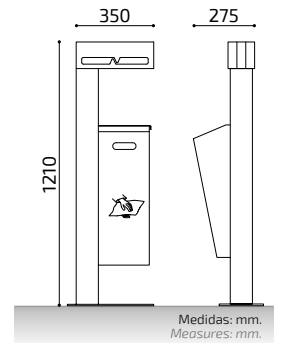

☑ Vaciado basculante. / Emptying tipping.

MINI BOX

H. GALVANIZADO • ACERO INOX. | GALVANIZED IRON • STAINLESS STEEL



34 L

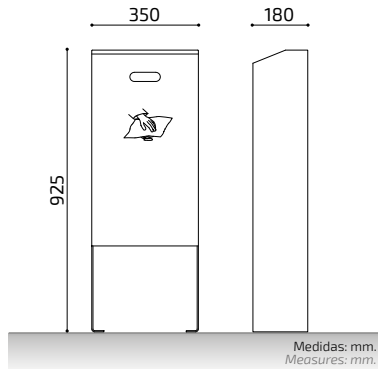

☑ Vaciado basculante. / Emptying tipping.

Dispensador Bolsas | Bag Dispenser SIMU

H. GALVANIZADO • ACERO INOX. | GALVANIZED IRON • STAINLESS STEEL



PSIMUV01



Caja bolsas (10 rollos de 500 bolsas)
Bag box (10 rolls of 500 bags)
Tamaño bolsa / Bag size: 250x340
(No incluidas / Not included)

BEMUSI02



Fijación poste o farola
Fixing pole or lamppost

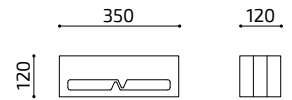

Dispensador Bolsas | Bag Dispenser PICK / AREN

ACERO INOX. | STAINLESS STEEL



DBPICKI01

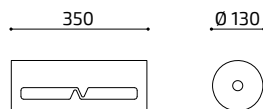

DBARENG01

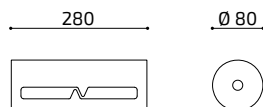

Tamaño bolsa / Bag size: 250x340
(No incluidas / Not included)

BEMUSI02

Bajo pedido AISI 316. / By request AISI 316.

Dispensador Bolsas | Bag Dispenser BAG

ACERO INOX. | STAINLESS STEEL



DBBAGI01



Caja bolsas (10 rollos de 500 bolsas)
Bag box (10 rolls of 500 bags)
Tamaño bolsa / Bag size: 250x340
(No incluidas / Not included)

BEMUSI02

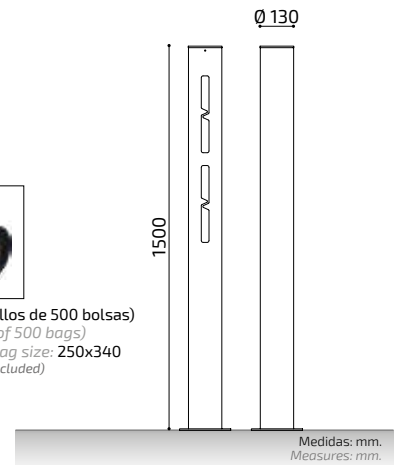

Bajo pedido AISI 316. / By request AISI 316.

Ceniceros | Ashtrays LILLA

HIERRO • ACERO INOX. | IRON • STAINLESS STEEL



Detalle apertura inferior
Lower opening

Cenicero | Ashtray ROU

H. GALVANIZADO • CORTEN + INOX. | GALVANIZED / CORTEN • STAINLESS STEEL

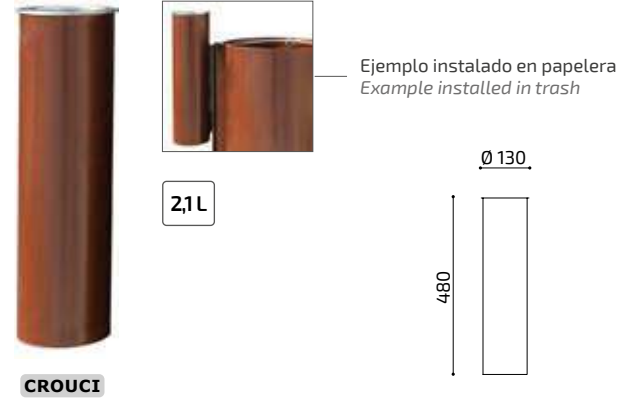

Cenicero | Ashtray KESMO

HIERRO | IRON



Cenicero | Ashtray FUMI

GALVANIZADO | GALVANIZED

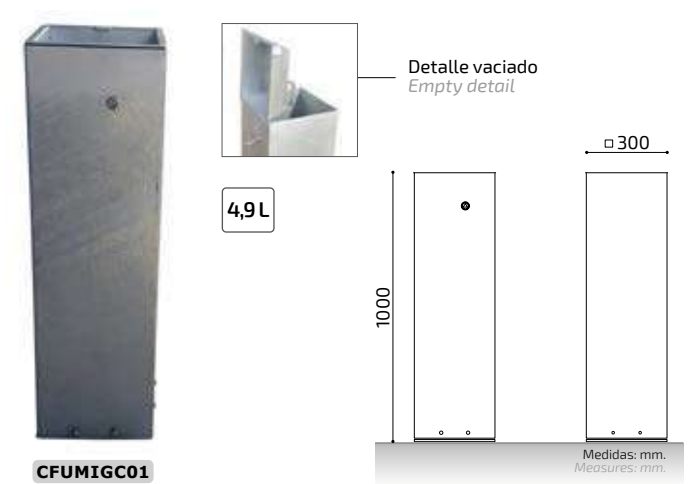

EAU

HIERRO + INOX. | IRON + STAINLESS STEEL



FEAU01

FEAU02

Modelos
Models

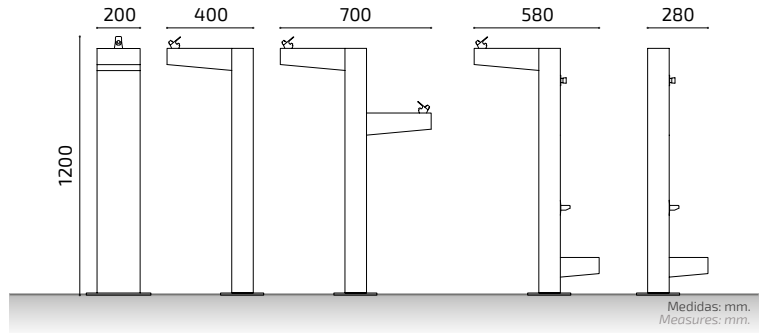

Opción gama económica (sin placa). / Economic option (without plate).

NIAGARA

HIERRO • CORTEN • INOX. | IRON • CORTEN • STAINLESS STEEL



VICTORIA

HIERRO • CORTEN • INOX. | IRON • CORTEN • STAINLESS STEEL

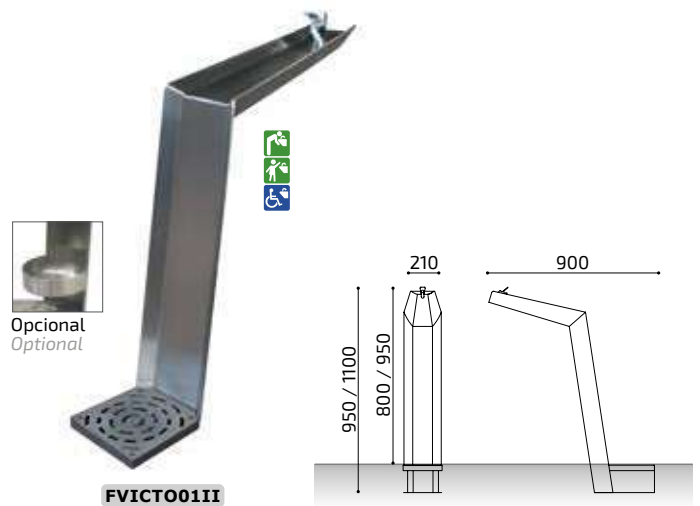

COR

HIERRO • CORTEN • INOX. | IRON • CORTEN • STAINLESS STEEL

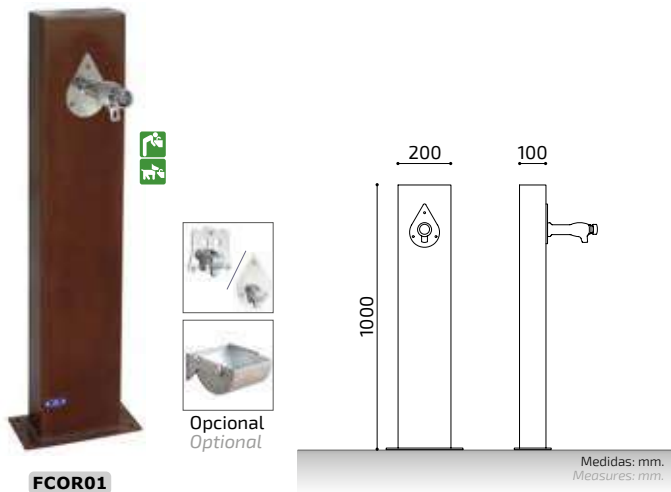

NILO

HIERRO • CORTEN • INOX. | IRON • CORTEN • STAINLESS STEEL

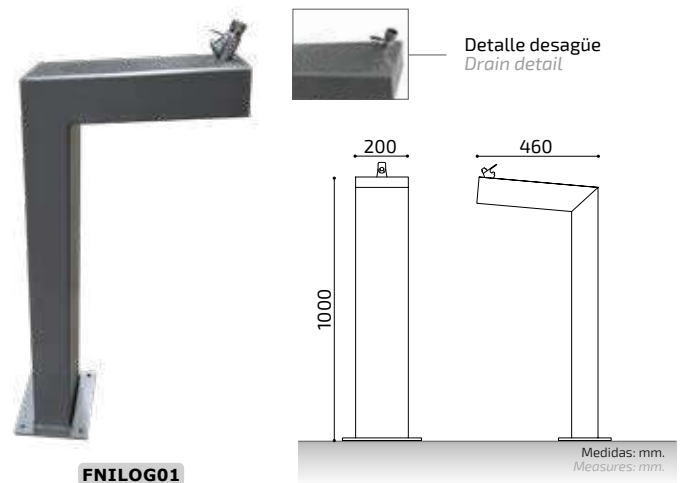

Opción gama económica (sin placa). / Economic option (without plate).

GOTA

HIERRO • CORTEN • INOX. | IRON • CORTEN • STAINLESS STEEL

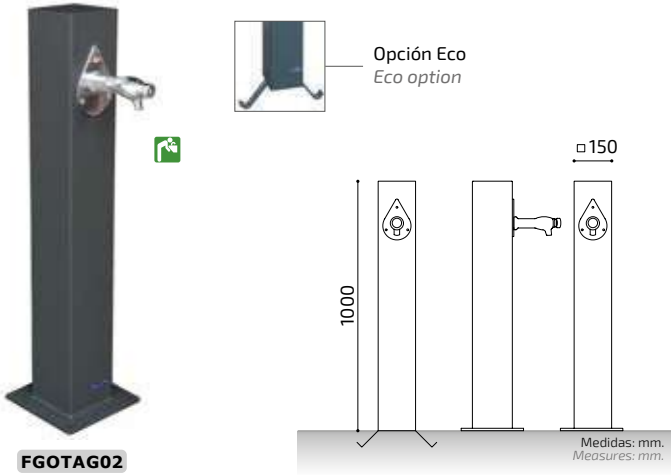

🗑️ Opción gama económica (sin placa). / Economic option (without plate).

SQUARE

HIERRO • CORTEN • INOX. | IRON • CORTEN • STAINLESS STEEL

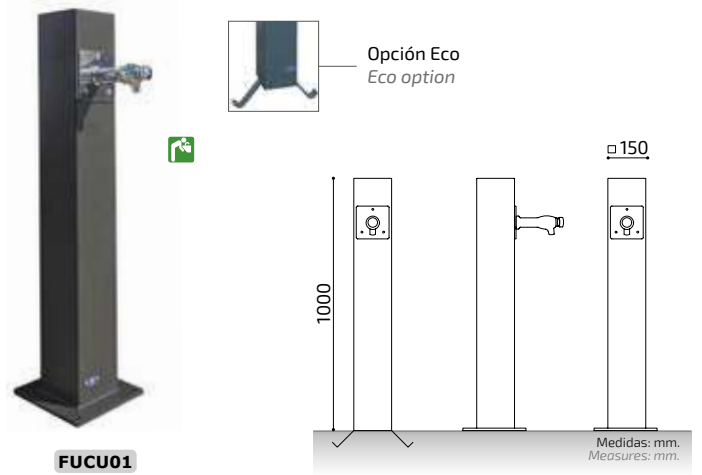

🗑️ Opción gama económica (sin placa). / Economic option (without plate).

DOGI

HIERRO • CORTEN • INOX. | IRON • CORTEN • STAINLESS STEEL



🗑️ Opción gama económica (sin placa). / Economic option (without plate).

PUPPY

HIERRO • CORTEN • INOX. | IRON • CORTEN • STAINLESS STEEL

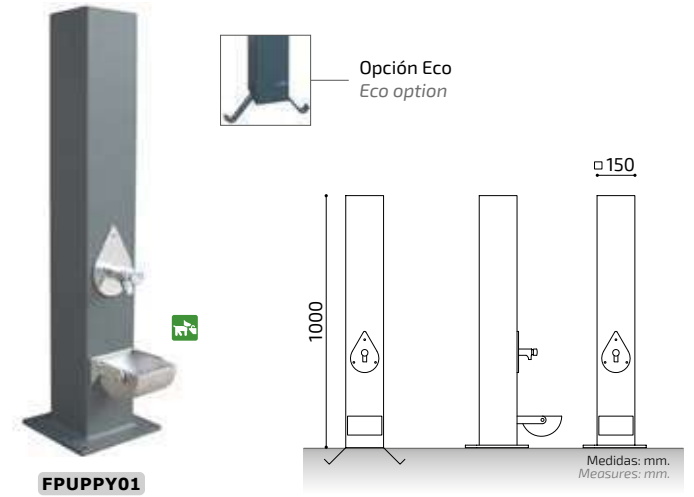

🗑️ Opción gama económica (sin placa). / Economic option (without plate).

CANINE

HIERRO • CORTEN • INOX. | IRON • CORTEN • STAINLESS STEEL



🗑️ Opción gama económica (sin placa). / Economic option (without plate).

CIRCLE

HIERRO • CORTEN • INOX. | IRON • CORTEN • STAINLESS STEEL

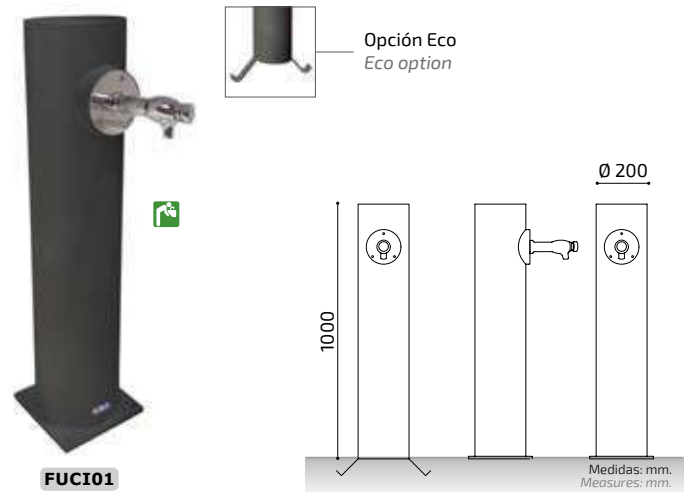

🗑️ Opción gama económica (sin placa). / Economic option (without plate).

COMBI

HIERRO • CORTEN • INOX. | IRON • CORTEN • STAINLESS STEEL

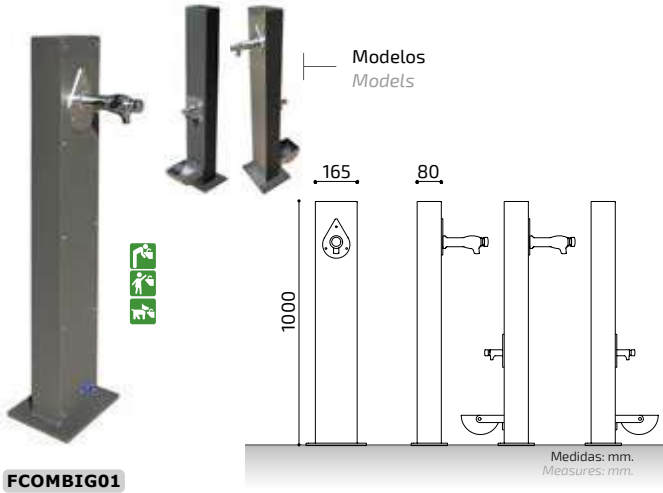

FCOMBIG01

Opción gama económica (sin placa). / Economic option (without plate).

RIN

HIERRO • CORTEN • INOX. | IRON • CORTEN • STAINLESS STEEL

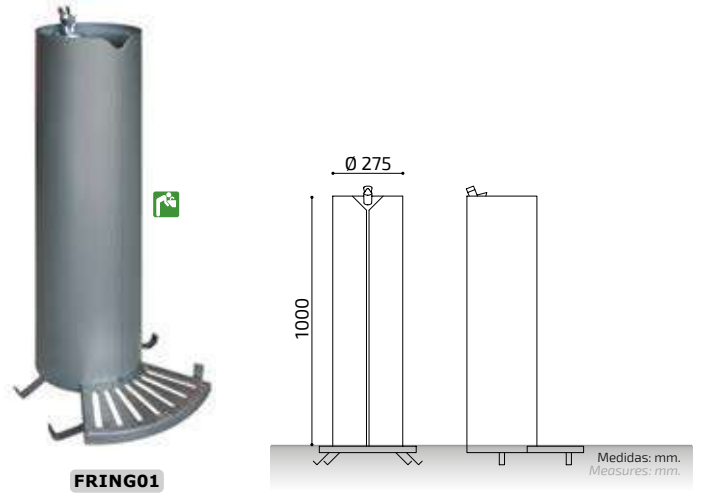

FRING01

Opción gama económica (sin placa). / Economic option (without plate).



Accesorios | Accessories REJILLAS / FOUNTAIN GRATES

HIERRO GALVANIZADO • INOX. | GALVANIZED IRON • STAINLESS STEEL

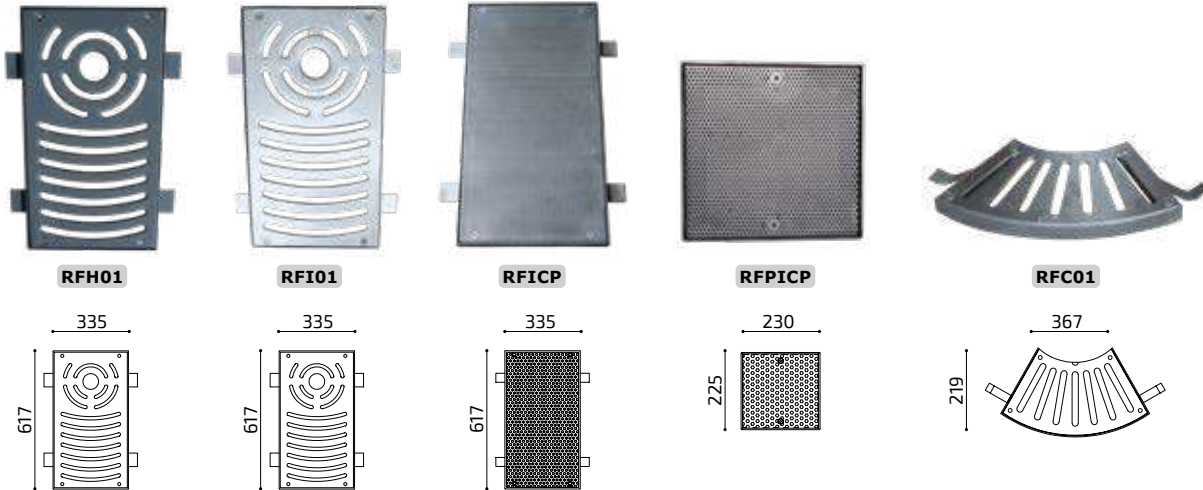

RFH01

RFI01

RFICP

RFPICP

RFC01



Accesorios | Accessories GRIFOS / TAPS

ACERO INOXIDABLE | STAINLESS STEEL



Pulsadores / Push buttons



Bebedores / Water troughs



PACIFIC

ACERO INOX. • CORTEN | STAINLESS STEEL • CORTEN STEEL

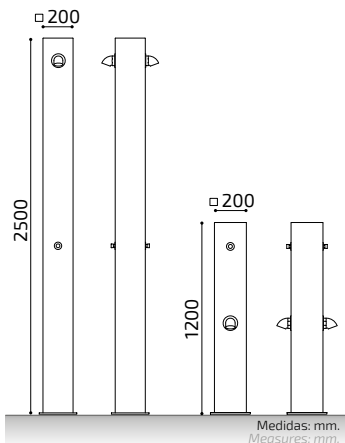

DPACIFICB03 **LPACIFICB04**

Bajo pedido AISI 316.
By request AISI 316.

1 a 4 Rociadores.
1 to 4 Sprinkler.

1 a 4 Pulsadores.
1 to 4 Push-buttons.

ARTIC

ACERO INOX. • CORTEN | STAINLESS STEEL • CORTEN STEEL

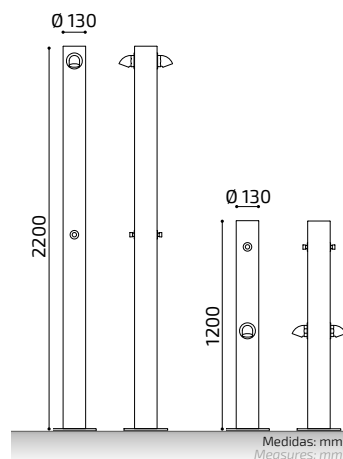

DARTICB02 **LARTICB01**

Bajo pedido AISI 316.
By request AISI 316.

1 a 2 Rociadores.
1 to 2 Sprinkler.

1 a 2 Pulsadores.
1 to 2 Push-buttons.

INDIC

ACERO INOX. • CORTEN | STAINLESS STEEL • CORTEN STEEL

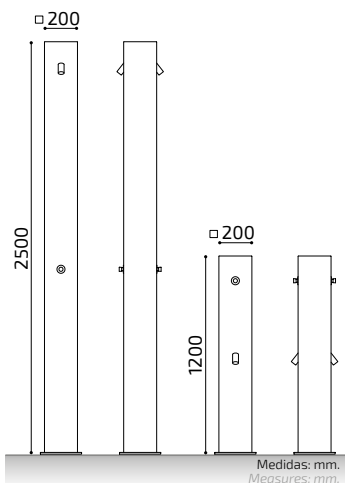

DINDICB01

LINDICB04

Bajo pedido AISI 316.
By request AISI 316.

1 a 4 Rociadores.
1 to 4 Sprinkler.

1 a 4 Pulsadores.
1 to 4 Push-buttons.

ATLANTIC

ACERO INOX. • CORTEN | STAINLESS STEEL • CORTEN STEEL

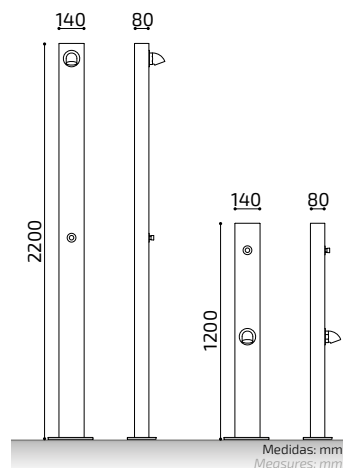

DATLANTICB01

LATLANTICB01

Bajo pedido AISI 316.
By request AISI 316.

1 Rociador.
1 Sprinkler

1 Pulsador.
1 Push-buttons.

OCEANIC

ACERO INOX. • CORTEN | STAINLESS STEEL • CORTEN STEEL

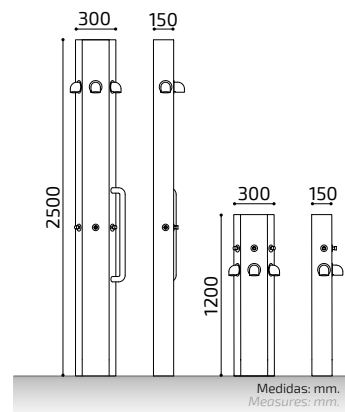

DOCEANICM03

LOCEANICM03

Bajo pedido AISI 316.
By request AISI 316.

1 a 3 Rociadores.
1 to 3 Sprinkler.

1 a 3 Pulsadores.
1 to 3 Push-buttons.

WIN

MADERA + ACERO INOX. | WOOD + STAINLESS STEEL

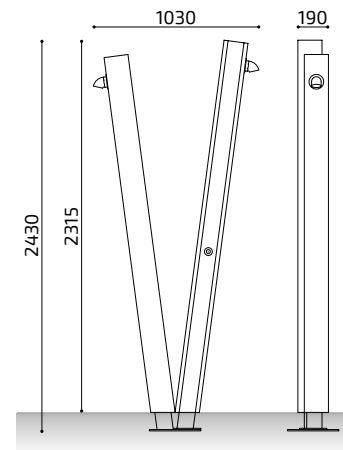

DWIN316I

Bajo pedido AISI 316.
By request AISI 316.

2 Rociadores.
2 Sprinkler.

2 Pulsadores.
2 Push-buttons.

SHOWY

HIERRO • CORTEN • ACERO INOX. | IRON • CORTEN STEEL • STAINLESS STEEL

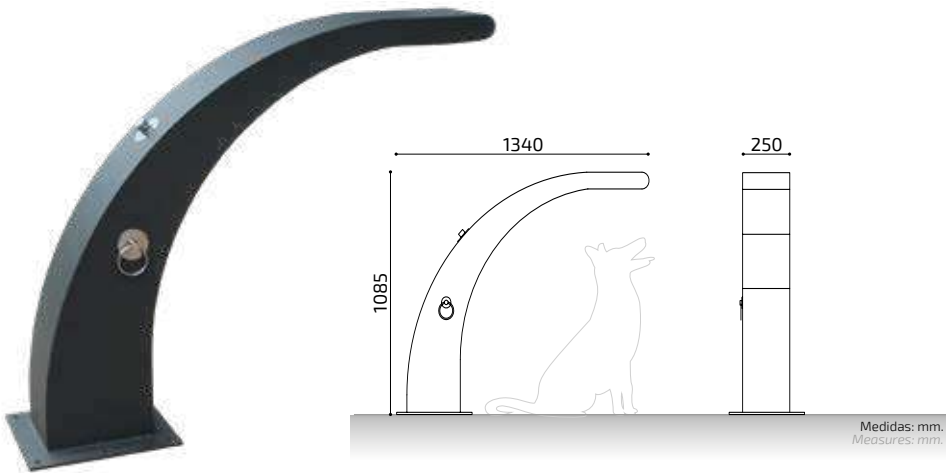

DSHOWY01G

1 Rociador. / 1 Sprinkler. 1 Pulsador. / 1 Push-button.



TARIMAS | PLATFORMS

MADERA | WOOD



TAMADUCHA

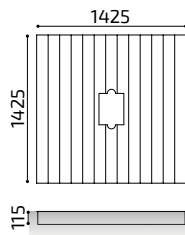

TAMAWINV

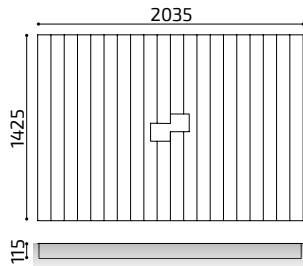

BANQUETAS | BENCHES

ACERO INOXIDABLE | STAINLESS STEEL



TABRIG001



BOCEANIS



SISTEMAS DRENANTES / BASE ANTIDESLIZANTE

DRAIN SYSTEM

HORMIGÓN | CONCRETE



FUJI

HIERRO GALVANIZADO • CORTEN | GALVANIZED IRON • CORTEN STEEL



-  Galvanizado
Galvanized iron
-  Acero corten
Corten steel
-  Imitación corten
Corten steel imitation

Fácil transporte
Easy transport



JFUJI10

A	B	C
990	990	460
490	490	460
990	990	950
990	490	460
990	490	950

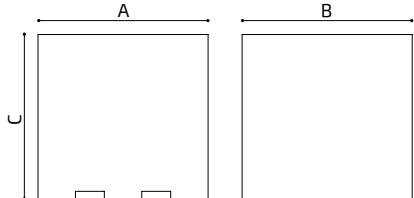

Medidas: mm.
Measures: mm.

 Opcional Hidrojardinera.
Optional Hidroplanter.

ACER

HIERRO GALVANIZADO • CORTEN | GALVANIZED IRON • CORTEN STEEL



-  Galvanizado
Galvanized iron
-  Acero corten
Corten steel
-  Imitación corten
Corten steel imitation

JACERO1

A	B	C
990	990	980
490	490	480
990	490	480
990	490	980
990	990	480

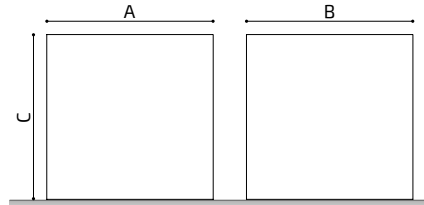

Medidas: mm.
Measures: mm.

 Opcional Hidrojardinera.
Optional Hidroplanter.

RAI

HIERRO GALVANIZADO • CORTEN | GALVANIZED IRON • CORTEN STEEL



-  Galvanizado
Galvanized iron
-  Acero corten
Corten steel
-  Imitación corten
Corten steel imitation

Transporte económico
Economic transport



JRAIC01

A	B	C
610	610	690

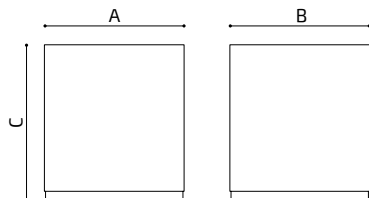

Medidas: mm.
Measures: mm.

 Opcional Hidrojardinera.
Optional Hidroplanter.

TRANSPI

HIERRO GALVANIZADO • CORTEN | GALVANIZED IRON • CORTEN STEEL



-  Galvanizado
Galvanized iron
-  Acero corten
Corten steel
-  Imitación corten
Corten steel imitation

Fácil transporte
Easy transport



Transporte económico
Economic transport



JTRANSPIC01

A	B	C
610	610	690

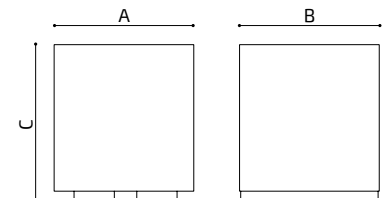

Medidas: mm.
Measures: mm.

 Opcional Hidrojardinera.
Optional Hidroplanter.

BUCAREST

HIERRO GALVANIZADO • CORTEN | GALVANIZED IRON • CORTEN STEEL



-  Galvanizado
Galvanized iron
-  Acero corten
Corten steel
-  Imitación corten
Corten steel imitation

JBUCAREST03

A	B	C
990	990	510
490	490	510
990	990	1000
990	490	510
990	490	1000

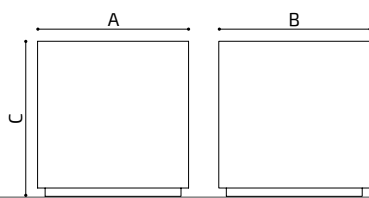

Medidas: mm.
Measures: mm.

 Opcional Hidrojardinera.
Optional Hidroplanter.

BRALLA

HIERRO GALVANIZADO • CORTEN | GALVANIZED IRON • CORTEN STEEL



-  Galvanizado
Galvanized iron
-  Acero corten
Corten steel
-  Imitación corten
Corten steel imitation

JBRALLA01

A	B	C	D
990	990	990	370
490	490	990	370
990	490	990	370

Listones madera en 1,2,3 ó 4 lados
Timber slats 1,2,3 or 4 sides

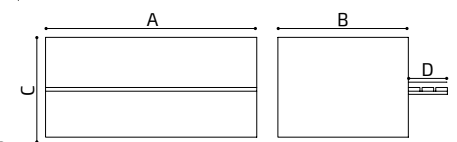

Medidas: mm.
Measures: mm.

 Opcional Hidrojardinera.
Optional Hidroplanter.

RECEI

HIERRO GALVANIZADO • CORTEN | GALVANIZED IRON • CORTEN STEEL



-  Galvanizado
Galvanized iron
-  Acero corten
Corten steel
-  Imitación corten
Corten steel imitation

JRECEI04C

A	B	C
990	990	460
490	490	460
990	990	950
990	490	460
990	490	950
750	750	700

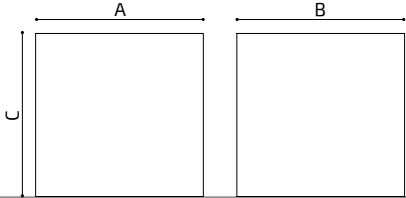

Medidas: mm.
Measures: mm.

 Opcional Hidrojardinera.
Optional Hidroplanter.

BAIA

HIERRO GALVANIZADO • CORTEN | GALVANIZED IRON • CORTEN STEEL



-  Galvanizado
Galvanized iron
-  Acero corten
Corten steel
-  Imitación corten
Corten steel imitation

JBAIAC01

A	B	C
1000	1000	920
500	500	420
1000	500	420
1000	500	920

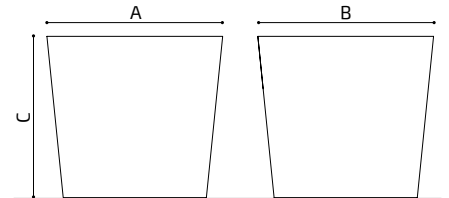

Medidas: mm.
Measures: mm.

 Opcional Hidrojardinera.
Optional Hidroplanter.

PREI

HIERRO GALVANIZADO • CORTEN | GALVANIZED IRON • CORTEN STEEL



-  Galvanizado
Galvanized iron
-  Acero corten
Corten steel
-  Imitación corten
Corten steel imitation

JPREI03

A	B	C
700	700	500
700	700	700

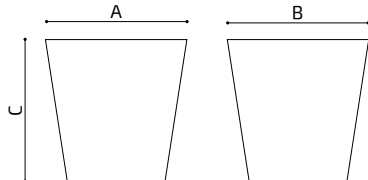

Medidas: mm.
Measures: mm.

 Opcional Hidrojardinera.
Optional Hidroplanter.

CLASIC

HIERRO GALVANIZADO • CORTEN | GALVANIZED IRON • CORTEN STEEL



-  Galvanizado
Galvanized iron
-  Acero corten
Corten steel
-  Imitación corten
Corten steel imitation

JCLASIC01

A	B	C
800	800	600
800	800	800

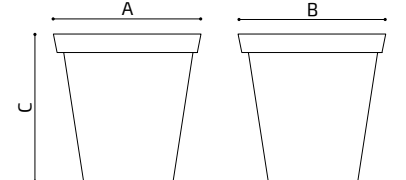

Medidas: mm.
Measures: mm.

 Opcional Hidrojardinera.
Optional Hidroplanter.

RESTA

HIERRO GALVANIZADO • CORTEN | GALVANIZED IRON • CORTEN STEEL



-  Galvanizado
Galvanized iron
-  Acero corten
Corten steel
-  Imitación corten
Corten steel imitation

JRESTA01C

 Consultar modelo Eco
Consult model Eco

A	B	C
970	300	750
970	250	750

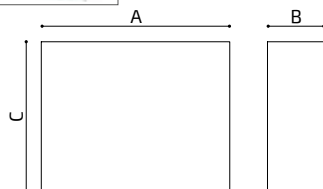

Medidas: mm.
Measures: mm.

 Opcional Hidrojardinera.
Optional Hidroplanter.

ARAN

HIERRO GALVANIZADO • CORTEN | GALVANIZED IRON • CORTEN STEEL



-  Galvanizado
Galvanized iron
-  Acero corten
Corten steel
-  Imitación corten
Corten steel imitation

JARAN01C

 Consultar modelo Eco
Consult model Eco

A	B	C
970	300	850
970	250	850

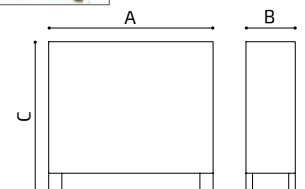

Medidas: mm.
Measures: mm.

 Opcional Hidrojardinera.
Optional Hidroplanter.

SHIP

HIERRO GALVANIZADO • CORTEN | GALVANIZED IRON • CORTEN STEEL



-  Galvanizado
Galvanized iron
-  Acero corten
Corten steel
-  Imitación corten
Corten steel imitation

JSHIPC01

A	B	C
1060	470	400

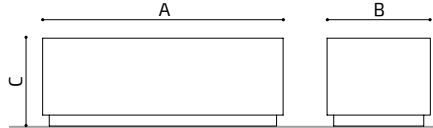

 Opcional Hidrojardinera.
Optional Hidroplanter.

Medidas: mm.
Measures: mm.

TEI

HIERRO GALVANIZADO • CORTEN | GALVANIZED IRON • CORTEN STEEL



-  Galvanizado
Galvanized iron
-  Acero corten
Corten steel
-  Imitación corten
Corten steel imitation

JHC02

A	B
∅ 950	700
∅ 950	500

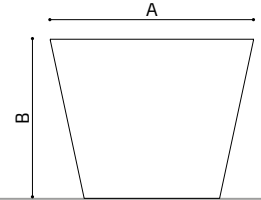

 Opcional Hidrojardinera.
Optional Hidroplanter.

Medidas: mm.
Measures: mm.

CURVI

HIERRO GALVANIZADO • CORTEN | GALVANIZED IRON • CORTEN STEEL



-  Galvanizado
Galvanized iron
-  Acero corten
Corten steel
-  Imitación corten
Corten steel imitation

JCURVI02L

A	B
∅ 950	900
∅ 950	490
∅ 630	900
∅ 630	490

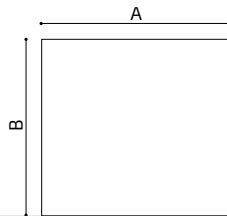

 Opcional Hidrojardinera.
Optional Hidroplanter.

Medidas: mm.
Measures: mm.

BRAND

HIERRO GALVANIZADO • CORTEN | GALVANIZED IRON • CORTEN STEEL



-  Galvanizado
Galvanized iron
-  Acero corten
Corten steel
-  Imitación corten
Corten steel imitation

JBRAND01

A	B
∅ 950	950
∅ 950	540
∅ 630	950
∅ 630	540

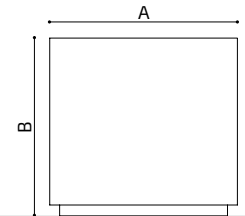

 Opcional Hidrojardinera.
Optional Hidroplanter.

Medidas: mm.
Measures: mm.

ALCOR

HIERRO • CORTEN • INOX. | IRON • CORTEN • STAINLESS STEEL



Jardinera - alcorque
construida a medida
Custom built planter
tree grate

ALCOR

 Opcional Hidrojardinera.
Optional Hidroplanter.

GREA

MADERA • HIERRO • CORTEN | WOOD • IRON • CORTEN



GREA01

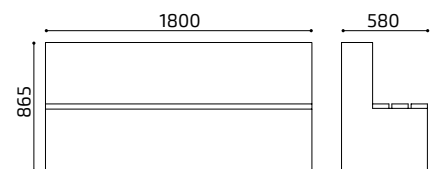

 Opcional Hidrojardinera.
Optional Hidroplanter.

Medidas: mm.
Measures: mm.

TRE

MADERA • HIERRO • CORTEN | WOOD • IRON • CORTEN



JTREG01

-  Galvanizado
Galvanized iron
-  Acero corten
Corten steel
-  Imitación corten
Corten steel imitation

A	B	C
738	738	570
1038	738	570
1038	1038	570

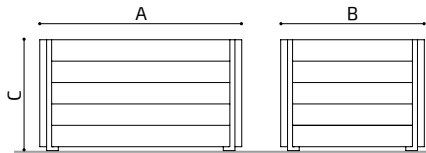

Medidas: mm.
Measures: mm.

 Opcional Hidrojardinera.
Optional Hidroplanter.

WOOD

MADERA • HIERRO • CORTEN • INOX. | WOOD • IRON • CORTEN • STAINLESS STEEL



JWOODI01

-  Galvanizado
Galvanized iron
-  Acero corten
Corten steel
-  Imitación corten
Corten steel imitation

A	B	C
738	738	570
1038	738	570
1038	1038	570

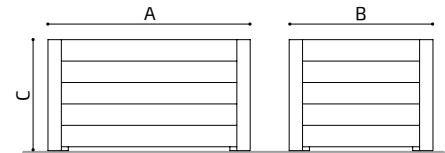

Medidas: mm.
Measures: mm.

 Opcional Hidrojardinera.
Optional Hidroplanter.

PINE

MADERA | WOOD



JPINE02

A	B	C
450	450	450
800	800	600

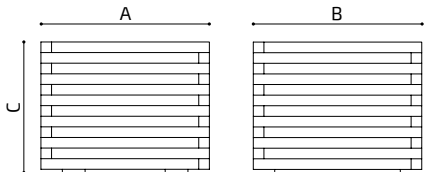

Medidas: mm.
Measures: mm.

 Opcional Hidrojardinera.
Optional Hidroplanter.

+ | HIDROJARDINERAS HIDROPLANTERS



MADERA • HIERRO • CORTEN • INOX. / WOOD • IRON • CORTEN • STAINLESS STEEL

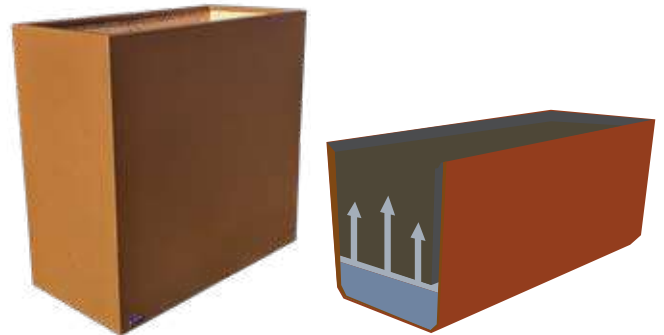

Si el cliente lo requiere, modificamos nuestras jardineras estándar a sistema de hidrojardineras incorporando un sistema de riego hidrológico con el objetivo de reducir el volumen de agua y reducir la frecuencia de riego.

If the client requires it, we modify our standard planters to a hydroplanter system incorporating a hydrological irrigation system in order to reduce the volume of water and reduce the frequency of irrigation.

+ | JARDINERAS A MEDIDA / CUSTOMIZED FLOWER PLANTERS

MADERA • HIERRO • CORTEN • INOX. | WOOD • IRON • CORTEN • STAINLESS STEEL



RELIGA CUADRADA

HIERRO GALVANIZADO | GALVANIZED IRON



ALCURE900

A	B	C
900	900	50
1000	1000	50
1100	1100	50
1200	1200	50

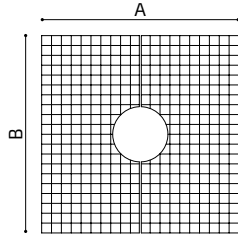

RELIGA CIRCULAR

HIERRO GALVANIZADO | GALVANIZED IRON



ALCIRED900

A	B
∅ 900	50
∅ 1000	50
∅ 1100	50
∅ 1200	50

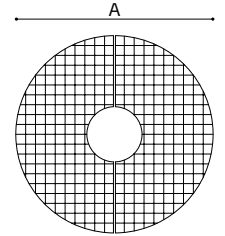

MARCO CUADRADO

HIERRO • CORTEN • INOX. | IRON • CORTEN STEEL • STAINLESS STEEL



ALCUMA1000G

A	B	C
1000	1000	200
1200	1200	200
1400	1400	200
1600	1600	200

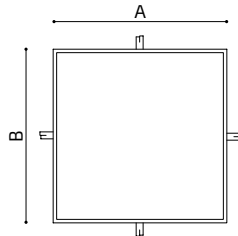

MARCO CIRCULAR

HIERRO • CORTEN • INOX. | IRON • CORTEN STEEL • STAINLESS STEEL



ALCIMAD900G

A	B
∅ 900	200
∅ 1600	200

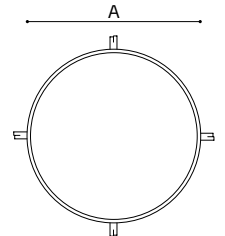

ONDA

HIERRO • CORTEN • INOX. | IRON • CORTEN STEEL • STAINLESS STEEL



ALON1000G

A	B	C
800	800	50
1000	1000	50
1200	1200	50
1500	1500	50

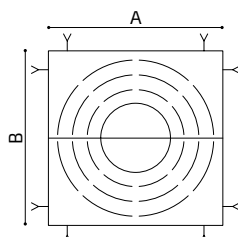

CONCENTRICO

HIERRO • CORTEN • INOX. | IRON • CORTEN STEEL • STAINLESS STEEL



ALCO1000G

A	B	C
800	800	50
1000	1000	50
1200	1200	50
1500	1500	50

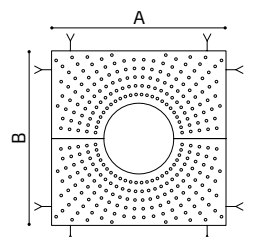

PUZZLE

HIERRO • CORTEN • INOX. | IRON • CORTEN STEEL • STAINLESS STEEL



ALPU1000G

A	B	C
800	800	50
1000	1000	50
1200	1200	50
1500	1500	50

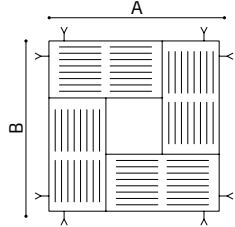

ROMBO

HIERRO • CORTEN • INOX. | IRON • CORTEN STEEL • STAINLESS STEEL



ALRO1000G

A	B	C
800	800	50
1000	1000	50
1200	1200	50
1500	1500	50

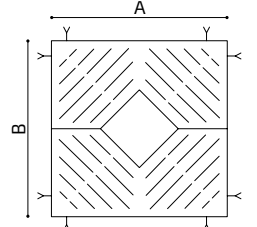

Protector árbol | Tree protector FICUS

H. GALVANIZADO • CORTEN • INOX. | GALVANIZED I. • CORTEN • STAINLESS STEEL



PTFIG

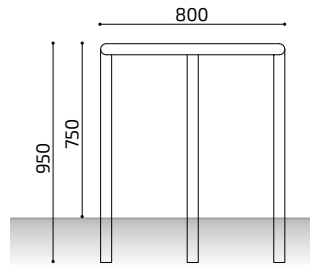

Protector árbol | Tree protector ROBLE

H. GALVANIZADO • CORTEN • INOX. | GALVANIZED I. • CORTEN • STAINLESS STEEL



PTROBLEGC

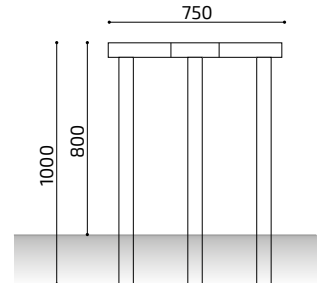

Protector árbol | Tree protector FRESNO

H. GALVANIZADO • CORTEN • INOX. | GALVANIZED I. • CORTEN • STAINLESS STEEL



PTFRESG

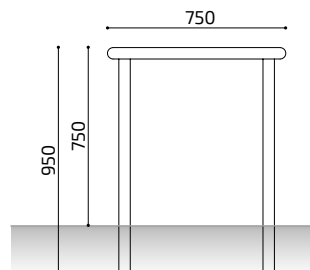

Protector árbol | Tree protector COPEY

H. GALVANIZADO • CORTEN • INOX. | GALVANIZED I. • CORTEN • STAINLESS STEEL



PTCOPEY

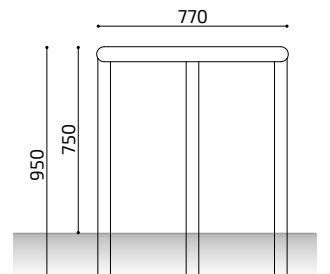

PARC

HIERRO GALVANIZADO • CORTEN | GALVANIZED IRON • CORTEN STEEL



BPARCG

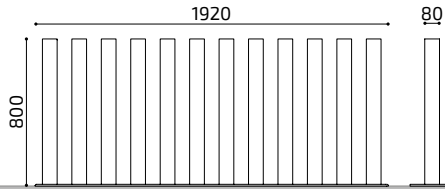

Medidas: mm.
Measures: mm.

PARC BCN

HIERRO GALVANIZADO • CORTEN | GALVANIZED IRON • CORTEN STEEL



BPARCBCNG

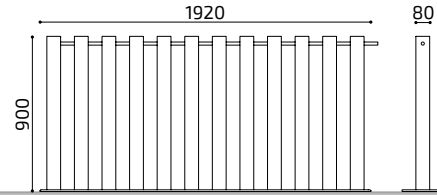

Medidas: mm.
Measures: mm.

PLAY

HIERRO GALVANIZADO | GALVANIZED IRON



VCOL



VCOLP01

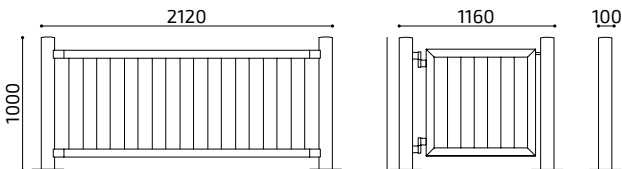

Medidas: mm.
Measures: mm.

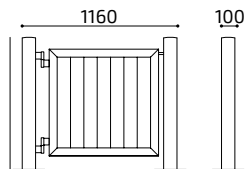

Medidas: mm.
Measures: mm.

FUSTAL

MADERA | WOOD



78020

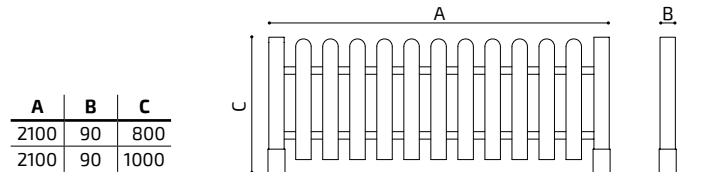

Medidas: mm.
Measures: mm.

YELLOWSTONE

MADERA + HIERRO GALVANIZADO | WOOD + GALVANIZED IRON

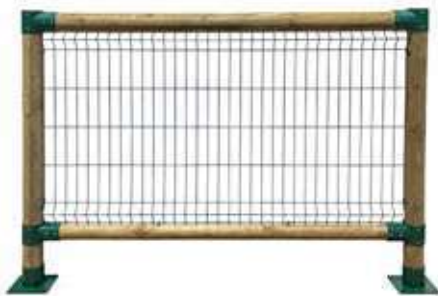

VYELLOWSTONE1.2V

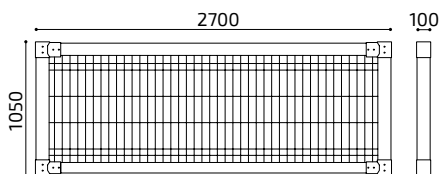

Medidas: mm.
Measures: mm.



LOCKER



PLÁSTICO POLIPROPILENO | POLYPROPYLENE PLASTIC



VL01AM



VL01RO



VL01AZ

- Diseño / Design
- Ecológica / Ecological
- Resistente / Resistant

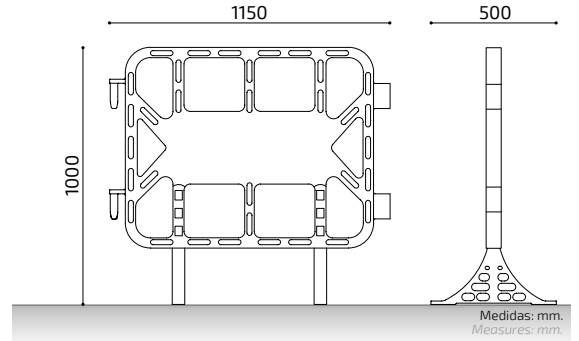

STOPPER



PLÁSTICO POLIPROPILENO | POLYPROPYLENE PLASTIC

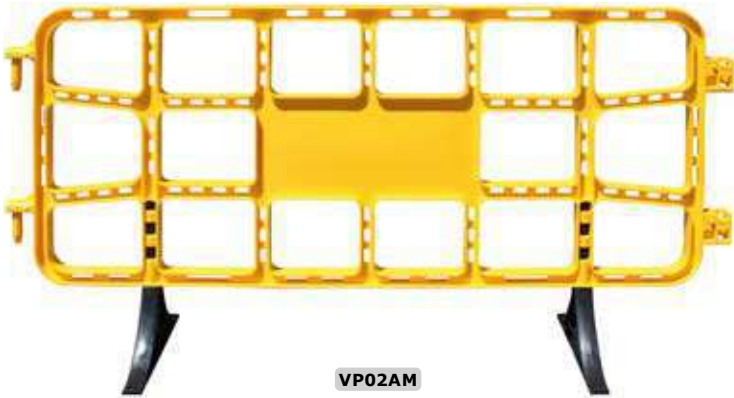

VP02AM



VP02RO



VP02AZ

- Diseño / Design
- Ecológica / Ecological
- Resistente / Resistant

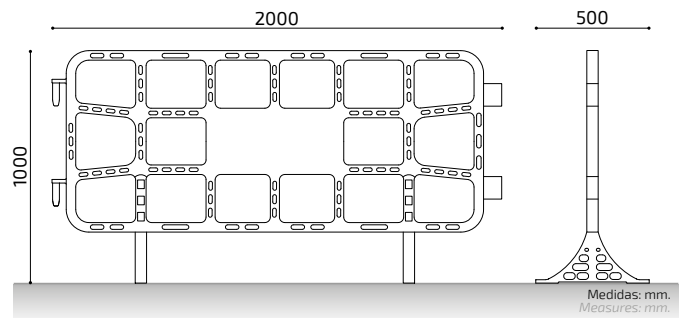

PERSONALIZACIÓN / CUSTOMIZATION

- Personalización del escudo, logo o texto identificativo en el panel central (gran formato para publicidad 600x280 mm).
Customizable: we can print your shield, logo or text in the centre panel (big advertising panel 600x280 mm).



PLEXTEN

PLÁSTICO | PLASTIC



VEXP01

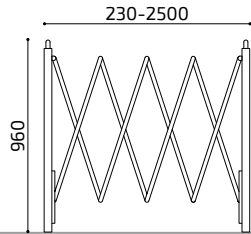

Medidas: mm.
Measures: mm.

CADENAS PLÁSTICO / PLASTIC CHAINS

PLÁSTICO | PLASTIC



CP825RB



CP825AN



25M Longitud.
Length.

POSTES CINTA EXTENSIBLE RETRACTABLE BELT BARRIER

HIERRO • ACERO INOXIDABLE | IRON • STAINLESS STEEL



PCEAICA2

PCEHNCA2

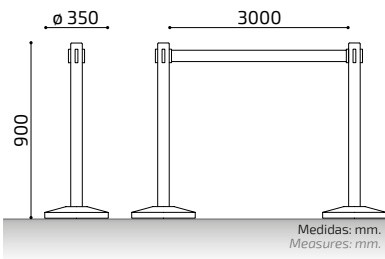

Medidas: mm.
Measures: mm.

3M Longitud cinta.
Tape length.

SEPARADOR DE CINTA PARED WALL RETRACTABLE BELT BARRIER

ACERO INOXIDABLE | STAINLESS STEEL



SCEP1



SCEPIR

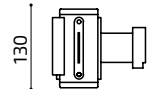
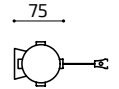

2,3M Longitud cinta.
Tape length.

Separador cinta extensible | Extensible tape separator

SPACE

PLÁSTICO | PLASTIC



SCEMN

ø 146

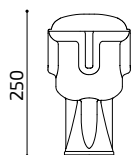

250



9M Longitud cinta.
Tape length.



ACCESORIOS ACCESSORIES



ANETO

PLÁSTICO PVC | PLASTIC PVC



Personalización logo o texto identificativo sobre la superficie del cono o sobre la reflectancia
 Custom traffic cones with logo or text printed on the surface or on the reflective tape

CP02

CP01A

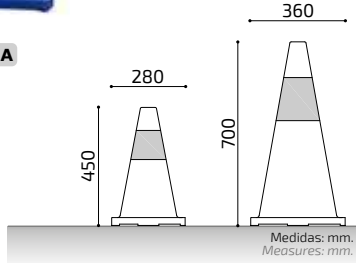

EVEREST

PLÁSTICO PE + CAUCHO | PLASTIC PE + RUBBER



Personalización logo o texto identificativo sobre la superficie del cono o sobre la reflectancia
 Custom traffic cones with logo or text printed on the surface or on the reflective tape

CPBC02

CPBC01A

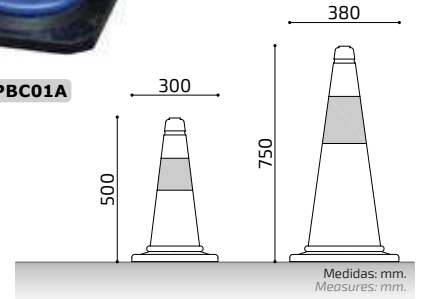

TEIDE

PLÁSTICO PE + TELA REFLECTANTE | PLASTIC PE + REFLECTIVE CLOTH



Luz interior:
Fija / intermitente
Internal illumination:
Fixed / flashing light



CPLEGABLE01

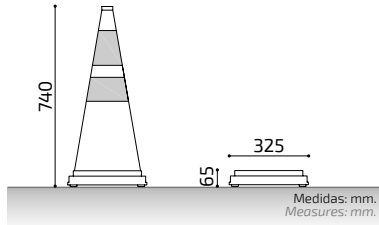

MONCAYO

PLÁSTICO PE + CAUCHO + TELA REFLECTANTE | PLASTIC PE + RUBBER + REFLECTIVE CLOTH



Luz interior:
Fija / intermitente
Internal illumination:
Fixed / flashing light



CPLEGABLE01

CPLEGABLE02

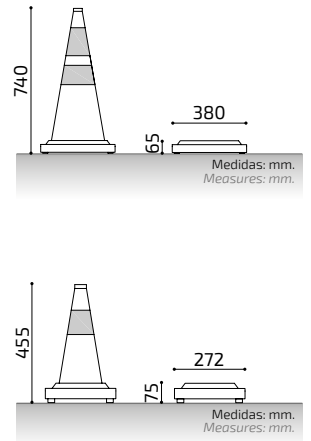

Tetrápodo policial | Police tetrapod

ALPES

PLÁSTICO | PLASTIC



CTETRA01

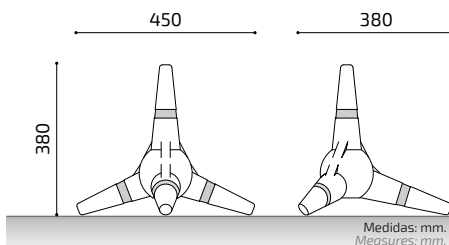

Enganche conos | Cones bar

CONEX

PLÁSTICO | PLASTIC



Detalle
Detail



PEXRB

PEXAN

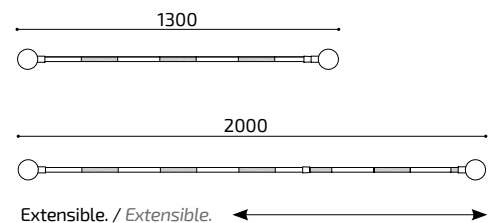

Separador Vial Modular | *Modular Road Separator*

MOMPE 

CAUCHO | RUBBER



MOMPEI

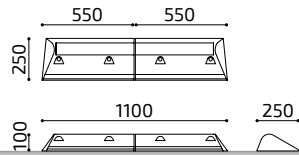

Homologado
Homologated
 Ajuntament
de Barcelona

MOMPED

Medidas: mm.
Measures: mm.

Separador Vial Modular | *Modular Road Separator*

MOMPE 2 

CAUCHO | RUBBER



MOMPEI2

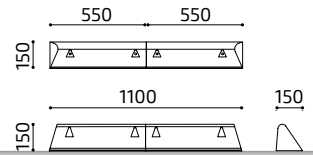

MOMPED2

Medidas: mm.
Measures: mm.

MOMPE 3 

CAUCHO | RUBBER



MOMPE3

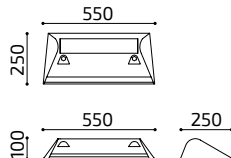

Medidas: mm.
Measures: mm.



TIGRE 

CAUCHO | RUBBER



TIGREVB01

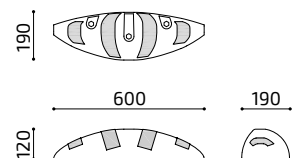

Medidas: mm.
Measures: mm.



PANTERA 

PLÁSTICO | PLASTIC



PANTERARB01

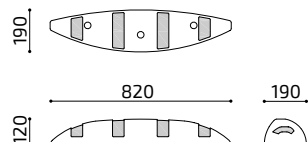

Medidas: mm.
Measures: mm.



PITÓN 

PLÁSTICO | PLASTIC



PITONRB01

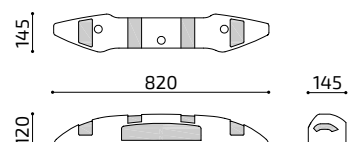

Medidas: mm.
Measures: mm.



Separador Vial | Road Separator **BUTTON**

CAUCHO | RUBBER



Separador Vial Asimétrico | Modular Road Asymetric **SEMARY**

CAUCHO | RUBBER

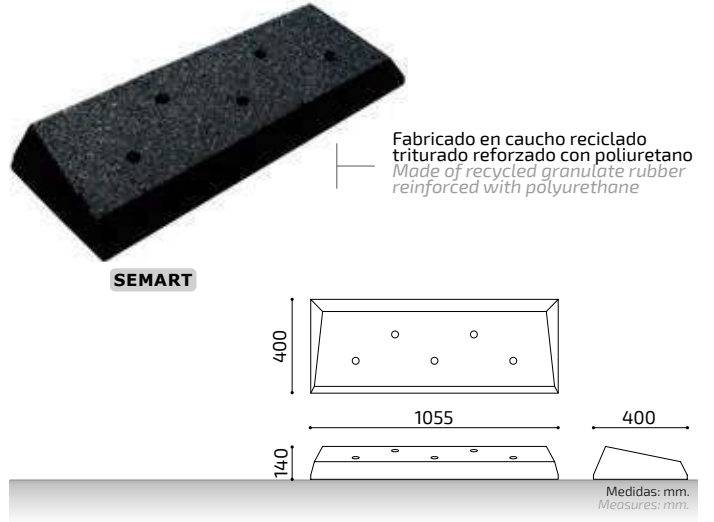

Separador Vial | Road Separator **SEVI**

CAUCHO | RUBBER

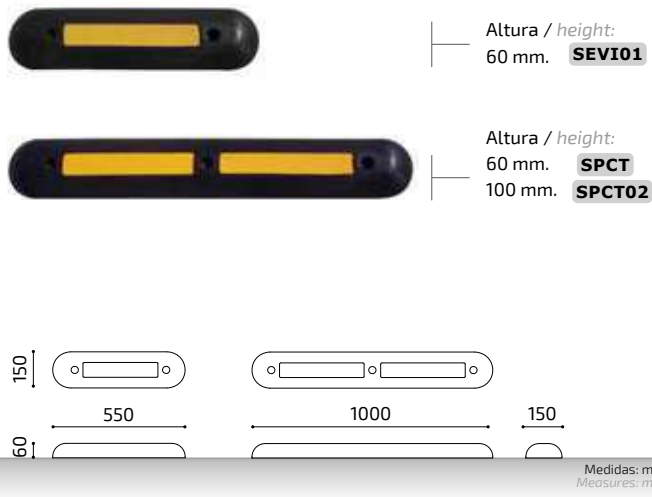

Separador Vial Modular | Modular Road Separator **SEVIMO**

CAUCHO | RUBBER



Cojín berlínés | Speed humps

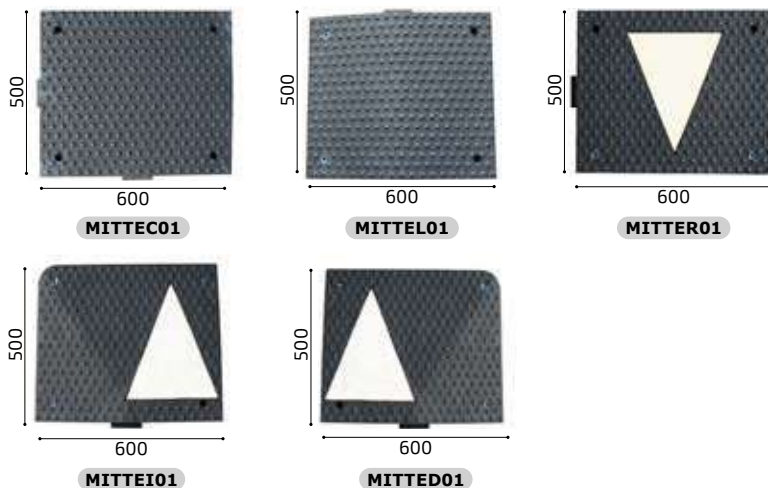

COJÍN BERLINÉS DE CAUCHO. ALTURA 70 MM. | RUBBER SPEED CUSHION. HEIGHT 70 MM.



Bandas Reductoras Velocidad | Speed Humps

CAUCHO | RUBBER

ALTURA 30 MM | HEIGHT 30 MM

 Pegatina microesfera Microsphere sticker	 Pegatina reflectante Reflective sticker	 Caucho Rubber
--	---	---

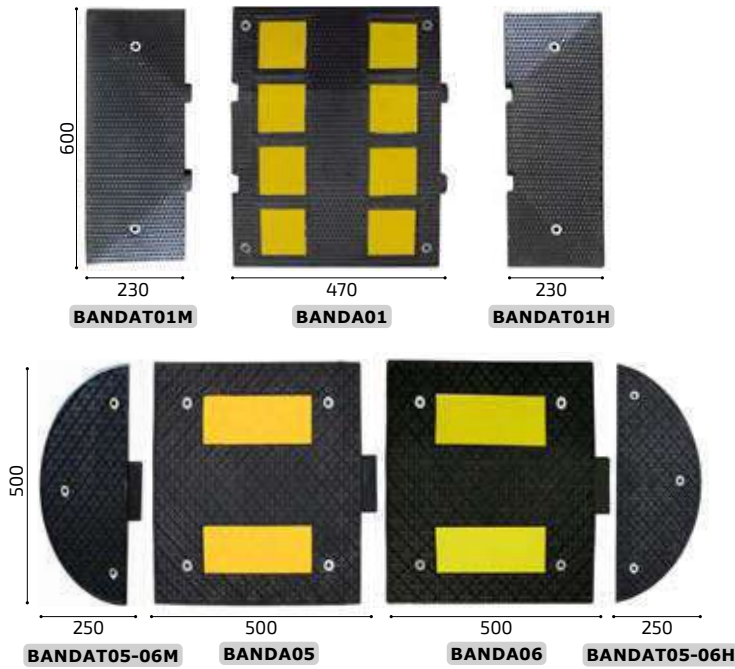

ALTURA 50 MM | HEIGHT 50 MM

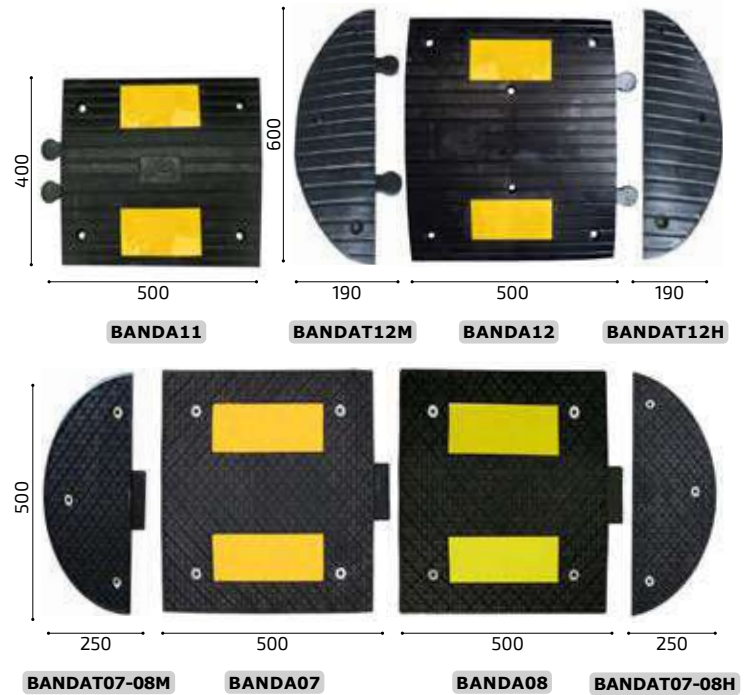
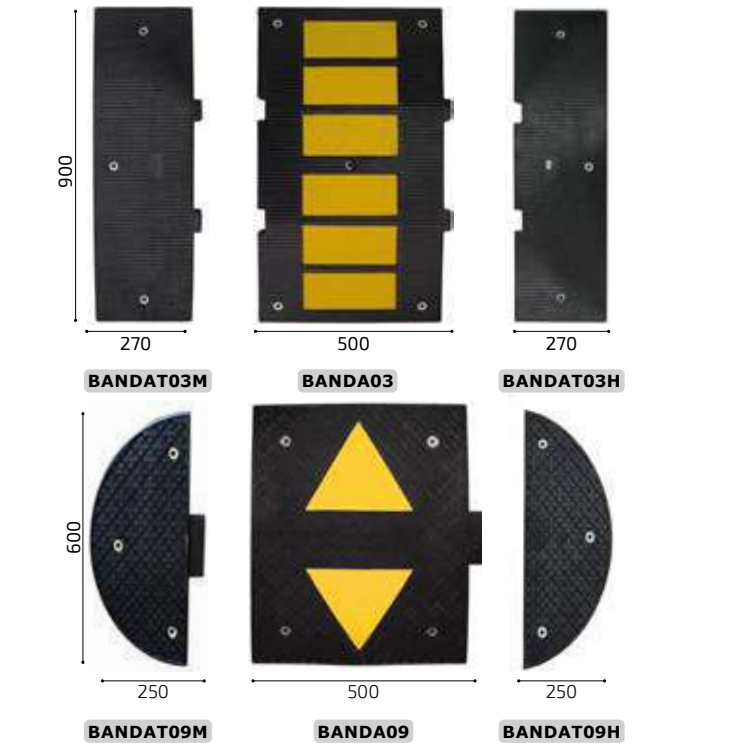

ALTURA 70 MM | HEIGHT 70 MM

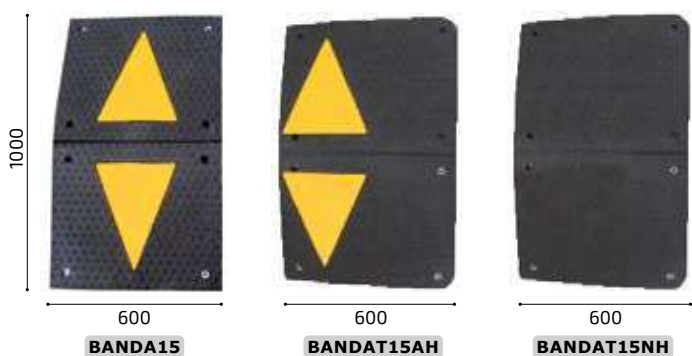

Bandas Reductoras Portátil | Portable Speed Humps

PORTBAND

PLÁSTICO | PLASTIC

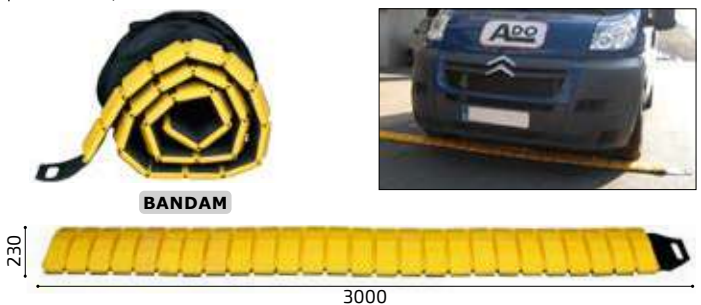

SILVER
PLÁSTICO | PLASTIC



TPSILVER01

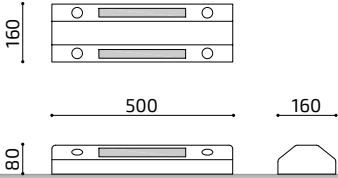

Medidas: mm.
Measures: mm.

INTERLAGOS
CAUCHO | RUBBER



TP03

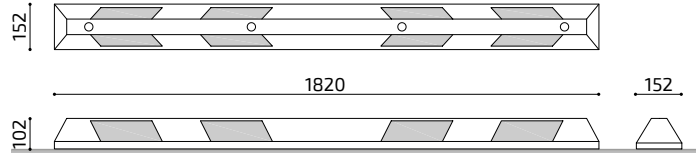

Medidas: mm.
Measures: mm.

CHESTE
HIERRO | IRON



TPCHESTE01AM



TPCHESTE02AM

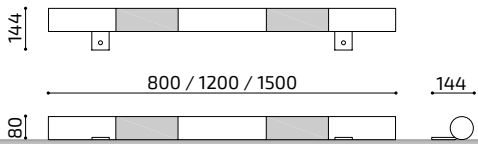

Medidas: mm.
Measures: mm.

DAKAR
HIERRO | IRON



TPH01



TPH02

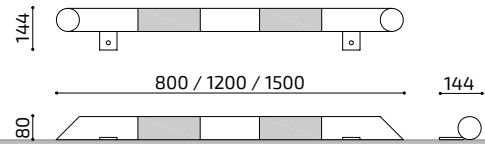

Medidas: mm.
Measures: mm.

FENIX
HIERRO | IRON



TPFENIX01RB



TPFENIX01NA

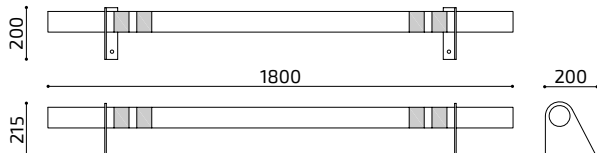

Medidas: mm.
Measures: mm.

JEREZ
HIERRO | IRON



TPJEREZRB01



TPJEREZAM01

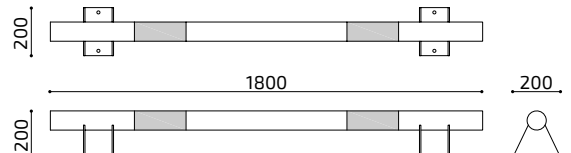

Medidas: mm.
Measures: mm.

CALIFORNIA

HORMIGÓN | CONCRETE



TPHCALIFORNIA

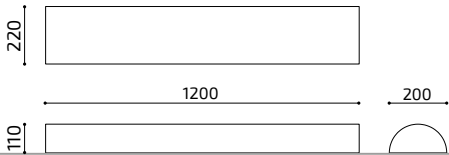

Medidas: mm.
Measures: mm.

DAYTONA

HORMIGÓN | CONCRETE



TPHO01

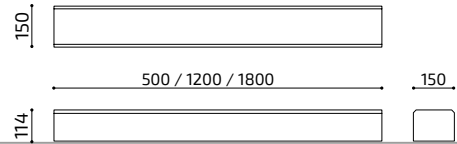

Medidas: mm.
Measures: mm.

TITAN

HIERRO GALVANIZADO • HIERRO • ACERO INOX. | GALVANIZED IRON • IRON • STAINLESS STEEL



TITAN01

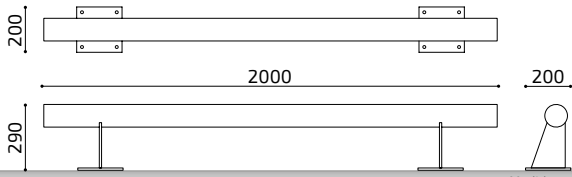

Medidas: mm.
Measures: mm.



PROTECTORES METÁLICOS / METALLIC PROTECTORS

HIERRO | IRON



ESPEJOS CONVEXOS CONVEX MIRRORS

PLÁSTICO | PLASTIC



Espejo exterior

Outdoor mirror

Ref.	Ø
ESPE60	600
ESPE80	800

ESPE60

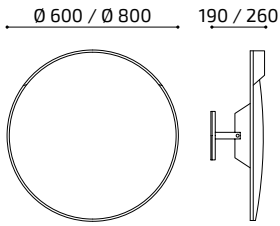

Espejo interior

Indoor mirror

Ref.	Ø
ESPI45	500
ESPI60	600

ESPI60

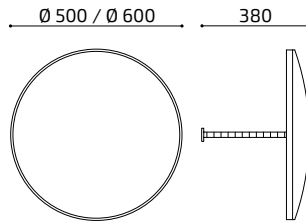

ISLETA HORMIGÓN CONCRETE TRAFFIC ISLAND

HORMIGÓN | CONCRETE



ISLETAHOR01

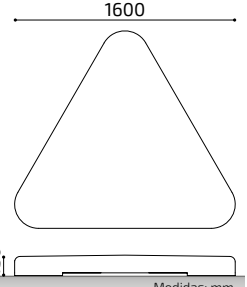

Medidas: mm.
Measures: mm.

CEPO INMOVILIZADOR / WHEEL IMMOBILIZER

HIERRO | IRON



CEPOP01



CEPOM01



CEPOG01

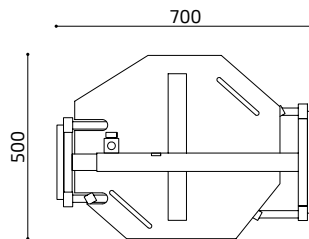
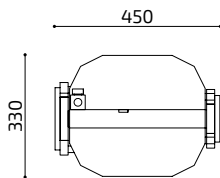
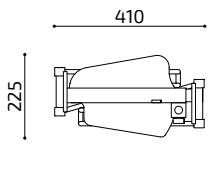

Salva zanjas | Trench cover SWIPER

FIBRA DE VIDRIO | GLASS REINFORCED COMPOSITE



SWIPER01

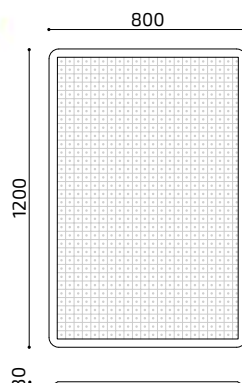

Medidas: mm.
Measures: mm.



Salva zanjas | Trench cover LIPER

FIBRA DE VIDRIO | GLASS REINFORCED COMPOSITE



LIPER01

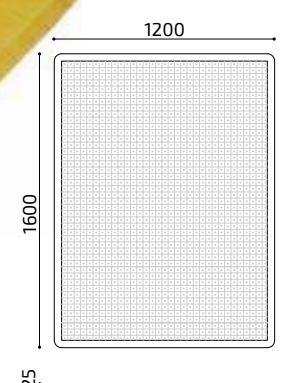

Medidas: mm.
Measures: mm.



Salva zanjas | *Trench cover*
PLASTRONG

PLÁSTICO + HIERRO | PLASTIC + IRON

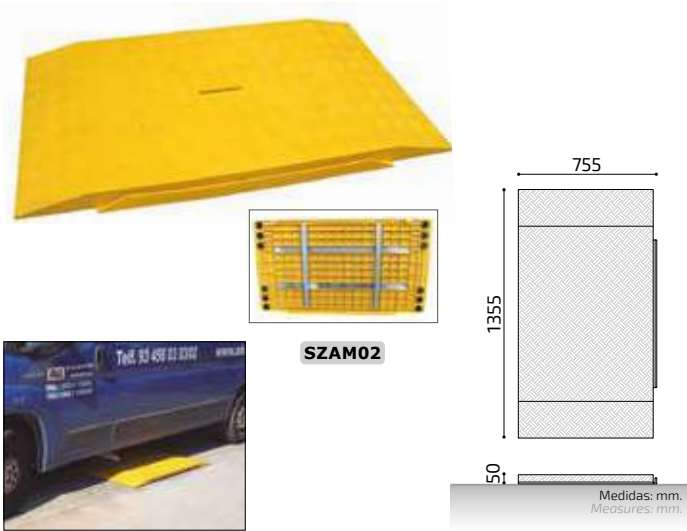

Salva rampas | *Safekerb Ramp*
FLAIER

PLÁSTICO | PLASTIC

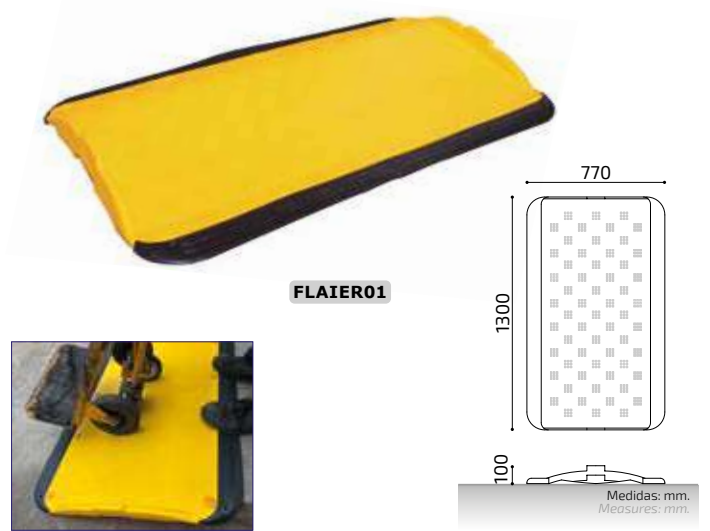

Protector cables | *Cable protector*
PROLINE

CAUCHO | RUBBER

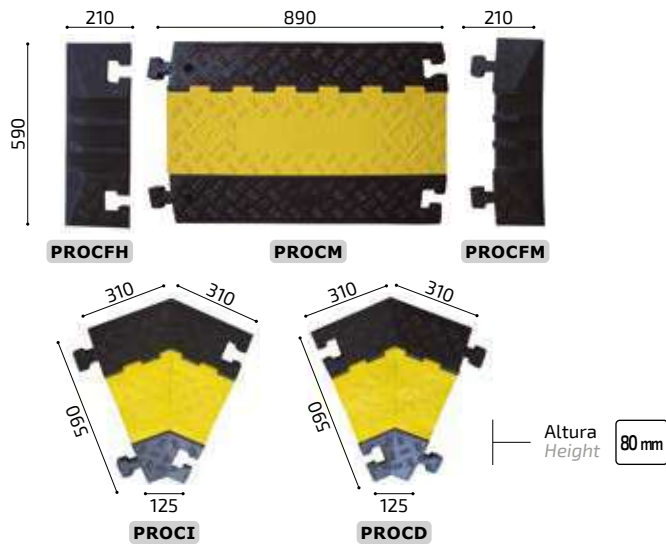

Protector cables | *Cable protector*
PROMARK

CAUCHO | RUBBER

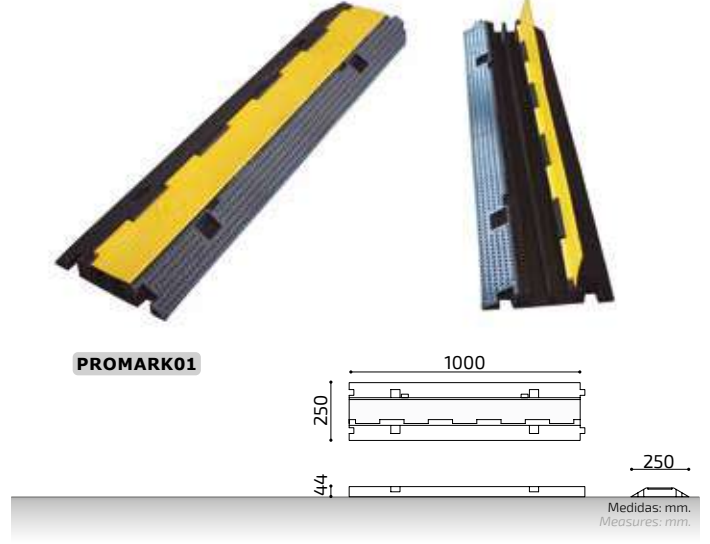

Protector cables | *Cable protector*
PROCABLE

PLÁSTICO | PLASTIC

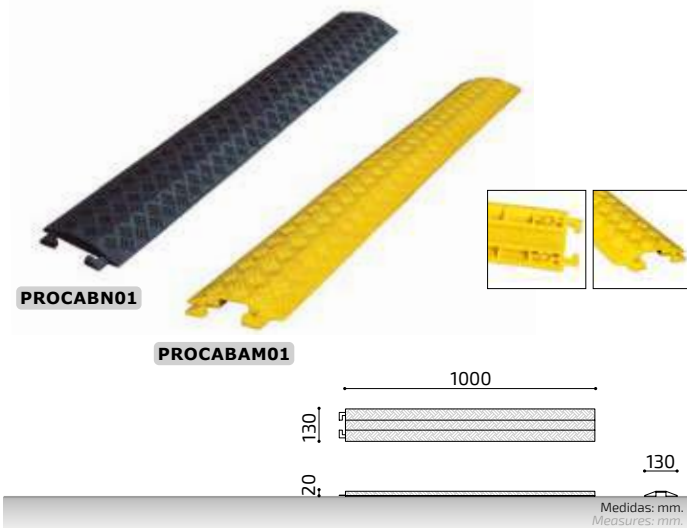

Protector cables | *Cable protector*
PROWIRE

PLÁSTICO | PLASTIC

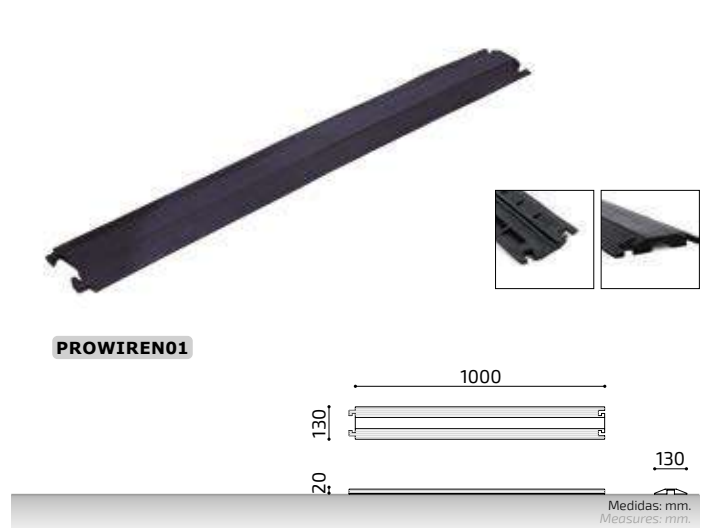

DOG STOP

ACERO INOXIDABLE | STAINLESS STEEL



DOGSTOPI01

DOGSTOPI02

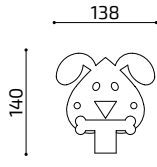
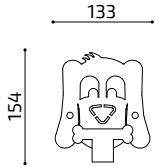

DOG PARK

ALUMINIO + ACERO INOXIDABLE | ALUMINIUM + STAINLESS STEEL



DOGPARKA

DOGPARKV

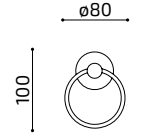
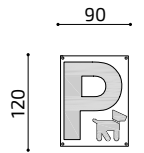

Protectores impactos | Impact protectors PAC / PAF / PAL

ESPUMA | FOAM



PACRB01

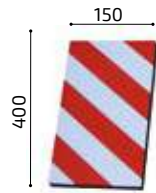

PALRB02



PAFAMN01

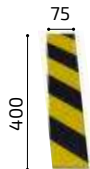

PALAMN01

Protectores impactos | Impact protectors PAG / BOAG

ESPUMA | FOAM



BOAG01

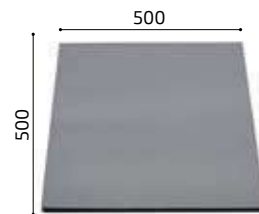

PAG

Protector impactos | Impact protector MAXI

ESPUMA | FOAM



MAXIAMN01

Medidas / Measures

25 m. x 700 mm.

10 m. x 700 mm.

5 m. x 700 mm.

Colores / Colors



Protector impactos | Impact protector IMPACT

PLÁSTICO | PLASTIC



IMPACT

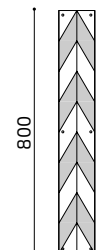

PARKLETS PLATAFORMAS URBANAS / PARKLETS URBAN PLATFORMS

MADERA • HORMIGÓN • HIERRO GALVANIZADO | WOOD • CONCRETE • GALVANIZED IRON



Plataformas modulares que extienden temporalmente la acera y transforman el espacio de estacionamiento, es una estrategia rápida y económica para proveer de mayor espacio a las ciudades, transformando los estacionamientos en pequeños parques públicos, extensiones de comercios, bares y restaurantes, salidas de colegios, ...

El objetivo principal es reimaginar el espacio público, transformando las calles en espacios de interacción social y fomento del comercio.

Modular platforms that temporarily extend the sidewalk and transform the parking space, is a quick and economic strategy that provides more space, by transforming parking lots into small public parks, shop, bars and restaurants extensions, space out of school,...
The main objective is to reimagine the public space, by transforming the streets into spaces for social interaction and commerce development.



La transformación de espacios de estacionamiento en extensiones de bares y restaurantes es una estrategia clave para la reactivación económica en muchas ciudades.

The transformation of parking lots into bars and restaurants extensions has been a strategy key for economic reactivation in many cities.

Gran variedad de combinaciones pudiendo elegir diferentes tipos de barandillas, jardineras, pavimentos,...

Wide variety of combinations, being able to choose different types of railings, planters, pavement,...



Protección / Protection



Barandillas
Railings



Jardineras
Planters

Pavimento / Pavement



Madera
Wood



Tapa con resaltos
Lid with projections

Rampa acceso abatible
Hinged access ramp



Múltiples combinaciones y medidas.

Lots of measures and combinations.



Fácil manipulación, montaje y reubicación de los módulos mediante transpalet.
Easy handling, assembly and relocation of the modules by using a pallet truck.



Espacio de dos plazas de estacionamiento = 1 parklet

Two parking lots space = 1 parklet.



Dos plazas estacionamiento son ocupadas por 40 vehículos al día.

Two parking lots are occupied by 40 cars a day.



1 parklet beneficia a 300 personas al día.

1 parklet benefits 300 people a dayspace = 1 parklet.

πραμα π

info@pramaplay.com